

treesse

Design for lifestyle

**LISTINO PREZZI \_ PRICE LIST**

**MARZO \_ MARCH 2025**

**ESSENTIAL**

# Indice - Index

Informazioni generali per l'utilizzo del listino vasche 2  
*General information on the use of this price-list bathtub*

Impianti vasche idromassaggio 3  
*Whirlpool bathtub system*

Rubineria 3  
*Taps*

Vasche Angolari - <i>Corner bathtubs</i>	
APP 150	6
APP 135	8
ASYX	10
HAITI	12
MATRIX SLIM	14
SLIDE	16
SURI 175	18

Vasche Rettangolari - <i>Rectangular bathtubs</i>	
APP 160	22
APP 170	24
APP 180	26
CLIZIA 105-120	28
CLIZIA	30
PLAYA	32
SURI 170	34

Vasche Classiche - <i>Classic bathtubs</i>	
BLANQUE 1690	38
BLANQUE 1810	40
BLANQUE 1880	42
BLANQUE 1915	44
PERLA	46

Linea Special - <i>Special line</i>	
GEN-D	49
GEN-X	50
GEN-X TOP	52
GEN-Y	54
GEN-Y TOP	56

Sistema Doccia - <i>Shower cubicles</i>	
ACQUAZZURRA 80/100	60
ACQUAZZURRA 90 S	61
ACQUAZZURRA 100 S	62

CONDIZIONI DI VENDITA - TERMS OF SALE	64
---------------------------------------	----

# Informazioni generali per l'utilizzo del listino vasche

## *General information on the use of this bathtub price-list*

### DIMENSIONI / DIMENSIONS

Tutte le misure sono espresse in centimetri.  
Dimension are given in centimeters.

### COLORE / COLOUR

I prezzi del listino si riferiscono a vasche di colore bianco.  
Listed price refer to white bathtubs.

### MODALITÀ D'ORDINE / ORDERING PROCEDURES

- 1) Scegliere l'articolo in base alla forma e dimensione.
  - 2) Scegliere la tipologia di impianto.
  - 3) Scegliere il verso di installazione in base alle proprie esigenze, facendo riferimento alla tabella riportata di seguito al presente testo.
  - 4) Scegliere il colore delle finiture, eventuali optional, la rubinetteria (se desiderata) e relativo colore.
- 1) Choose the article based on shape and dimension.
  - 2) Choose system type.
  - 3) Choose installation direction based on your own needs, using the table below as reference.
  - 4) Choose finishings colour, optionals, faucets (if desired) and relative colour.

### INSTALLAZIONE VASCHE RETTANGOLARI / INSTALLATION RECTANGULAR BATHTUB

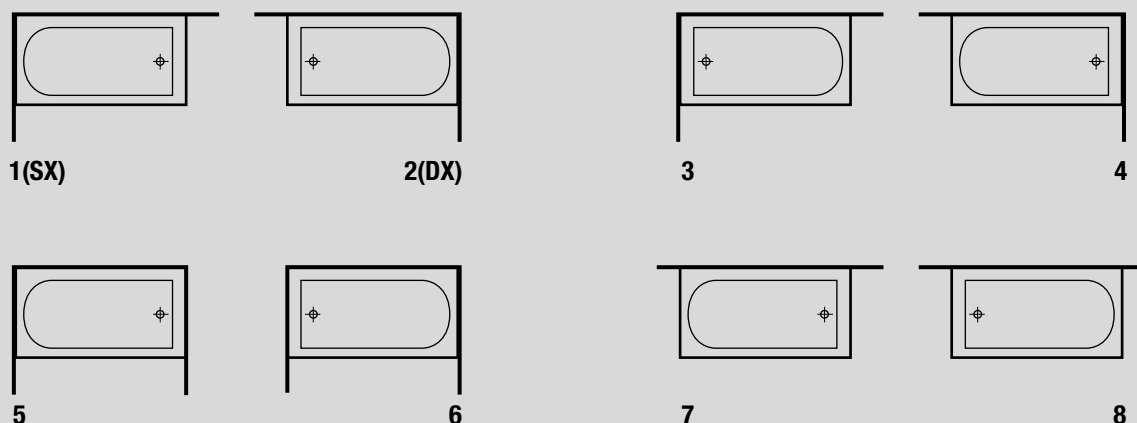

### INSTALLAZIONE VASCHE ASIMMETRICHE / INSTALLATION ASYMMETRIC BATHTUB

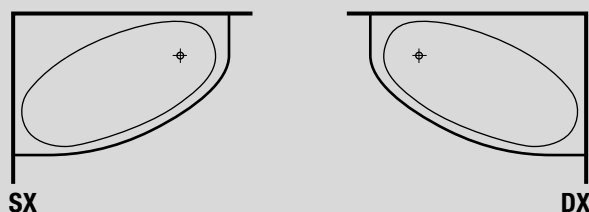

### LIMITI DI RAPPRESENTATIVITÀ / SPECIFICATION LIMITS

I dati tecnici, le descrizioni e le rappresentazioni grafiche dei beni riportati sul presente listino, sono puramente indicativi.  
Le specifiche dimensionali e d'installazione sono riportate con esattezza sulle schede tecniche, consultabili sul sito [www.gruppotreesse.it](http://www.gruppotreesse.it).  
L'azienda si riserva la facoltà di modificare la produzione a suo insindacabile giudizio, senza obbligo di preavviso.

Technical data, descriptions and graphic representations of the goods in this price-list are merely approximate.  
The dimensional and installation specifications are stated exactly on the technical information sheet, available on the website [www.gruppotreesse.it](http://www.gruppotreesse.it).  
The firm reserves the right to modify its production at its sole discretion and without prior notice.

## IDROMASSAGGIO

### Impianto STANDARD DIGITALE (STD)

- Pulsante digitale on/off per avviamento dell'impianto.
- Regolazione manuale del flusso dell'aria.
- Bocchette orientabili e chiudibili completamente.
- Sensore di livello.
- Temporizzatore di sicurezza per arresto automatico dell'impianto.

### Impianto STANDARD EXTRA (STX)

- Pulsante digitale on/off per avviamento dell'impianto.
- Regolazione digitale del flusso dell'aria.
- Bocchette orientabili e chiudibili completamente.
- Valvola motorizzata per regolazione dell'aria.
- Sensore di livello.
- Temporizzatore di sicurezza per arresto automatico dell'impianto.
- Faro subacqueo.

### Impianto IDROMASSAGGIO CON AVVIAMENTO PNEUMATICO (PRA)

- Pulsante pneumatico on/off per avviamento dell'impianto.
- Regolazione manuale del flusso aria.
- Bocchette orientabili e chiudibili completamente.
- Sensore di livello.
- Temporizzatore di sicurezza per arresto automatico dell'impianto.

## WHIRPOOL

### STANDARD DIGITAL system (STD)

- System digital on/off button for system start-up.
- Manual regulation of air flow.
- Nozzles can be completely oriented and closed.
- Level sensor.
- Safety timer for automatic stop.

### STANDARD EXTRA system (STX)

- System digital on/off button for system start-up.
- Digital regulation of air flow.
- Nozzles can be completely oriented and closed.
- Motorized valve for air regulation.
- Level sensor.
- Safety timer for automatic stop.
- Underwater lamp.

### WHIRLPOOL WITH PNEUMATIC START-UP system (PRA)

- Pneumatic on/off button for system start-up.
- Manual regulation of air flow.
- Nozzles can be completely oriented and closed.
- Level sensor.
- Safety timer for automatic stop.

## IDROMASSAGGIO + AIRPOOL

### Impianto DIGITAL WHIRLPOOL AIRPOOL (AWA)

- Comandi digitali per le funzioni di idromassaggio ed airpool.
- Bocchette orientabili e chiudibili completamente.
- Funzione di Blowing After per lo svuotamento dall'acqua residua nell'impianto airpool a fine ciclo e asciugatura delle condotte. Il processo avviene a vasca vuota.
- Sensore di livello.
- Temporizzatore di sicurezza per arresto automatico dell'impianto.
- Faro subacqueo.

## WHIRLPOOL + AIRPOOL

### DIGITAL WHIRLPOOL AIRPOOL system (AWA)

- Digital commands for whirlpool and airpool.
- Nozzles can be completely oriented and closed.
- Blowing After function to drain remaining water once the cycle is over and to dry the pipes. The process takes place while the tub is empty.
- Level sensor.
- Safety timer for automatic stop.
- Underwater lamp.

## Rubinetteria *Taps*

### MIX



Miscelatore monocomando con deviatore e doccia  
Single-lever mixer with diverter and hand-shower

### MLQ

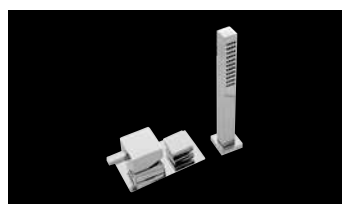

Miscelatore monocomando quadrato con deviatore e doccia  
Squared single-lever mixer with diverter and hand-shower

### LINE

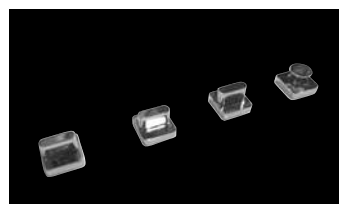

Rubinetteria acqua calda/fredda con deviatore e doccia semi-incasso  
Hot/cold water taps with diverter and semi-built in hand shower

### RUE



Rubinetteria elettronica con deviatore doccia semi-incasso  
Electronic water taps with diverter and semi-built in hand shower

## BOCCE EROGAZIONE / WATERFALL SPOUTS

### BVG



Bocca a vela grande  
Large sail-shaped

### BVP



Bocca a vela piccola  
Small sail-shaped

### BVC



Bocca a vela piccola modello cubo  
Small sail-shaped Cubo model



# Vasche angolari 5

## *Corner Bathtubs*

<b>APP 150</b>	6
<b>APP 135</b>	8
<b>ASYX</b>	10
<b>HAITI</b>	12
<b>MATRIX SLIM</b>	14
<b>SLIDE</b>	16
<b>SURI 175</b>	18

# App 150 150 x 100 x 55h

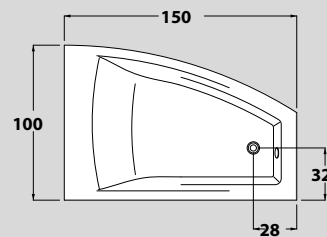

Scheda tecnica disponibile sul sito [www.gruppotes.it](http://www.gruppotes.it)  
 Technical drawing available on [www.gruppotes.it](http://www.gruppotes.it)

## INSTALLAZIONE / INSTALLATION

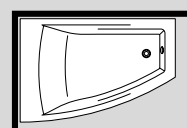

(SX)

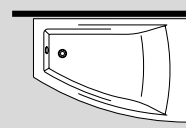

(DX)

MODELLO MODEL	ARTICOLO ARTICLE	DESCRIZIONE DESCRIPTION	
<b>VASCA INCASSO - BUILT-IN BATHTUB</b>			
<b>VIN</b>	<b>V4250</b>	<b>INCASSO BUILT-IN</b>	<b>650</b>
<b>VASCA CON TELAIO - BATHTUB WITH FRAME</b>			
<b>VTL</b>	<b>V4251</b>	<b>SENZA IDROMASSAGGIO WITHOUT WHIRLPOOL</b>	<b>950</b>
<b>VASCA CON IDROMASSAGGIO - BATHTUB WITH WHIRLPOOL</b>			
<b>PRA</b>	<b>V4252</b>	<b>IDROMASSAGGIO CON AVVIAMENTO PNEUMATICO WHIRLPOOL WITH PNEUMATIC START</b>	<b>1.750</b>

## PANNELLI PER VASCA - PANELS FOR BATHTUB

	<b>V425F</b>	<b>PANNELLO FRONTALE FRONTAL PANEL</b>	<b>300</b>
--	--------------	--	------------

## DOTAZIONI VASCA BATHTUB SUPPLY

	VIN-VTL	PRA
• <b>JET IDROMASSAGGIO</b> - WHIRLPOOL JET	—	6
• <b>JET AIRPOOL</b> - AIRPOOL JET	—	—
• <b>COLONNA DI SCARICO</b> - DRAIN COLUMN	●	●
• <b>SENSORE DI LIVELLO</b> - LEVEL SENSOR	—	●
• <b>MASSIMO CONTENUTO ACQUA</b> - MAX WATER CAPACITY	220 LT.	220 LT.

### LEGENDA - LEGEND

- **Di serie** - Of series
- **Non disponibile** - Not available

	RUBINETTERIA E CUSCINO TAPS AND PILLOW		CROMO CHROME
MIX	<b>MISCELATORE MONOCOMANDO CON DEVIATORE E DOCCETTA</b> SINGLE-LEVER MIXER WITH DIVERTER AND HAND-SHOWER		400
BVP	<b>BOCCA A VELA PICCOLA</b> SMALL SAIL-SHAPED		200
COE	<b>SUPPLEMENTO PER COLONNA DI SCARICO CON EROGAZIONE</b> SURCHARGE POP UP & OVERFLOW WITH WATER OUTLET SPOUT		80
CUS	<b>CUSCINO POGGIATESTA MORBIDO NERO</b> SOFT PILLOW HEADREST BLACK	150	
FOR	<b>SUPPLEMENTO PER FORATURA RUBINETTERIA DIVERSA DA QUELLE PRESENTI SUL NOSTRO LISTINO</b> SURCHARGE FOR TAPS DRILLING IF TAPS ARE NOT OUR MODELS	500	

# 8 App 135 135 x 135 x 55h

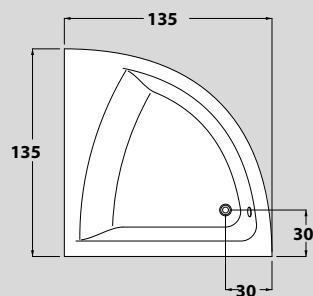
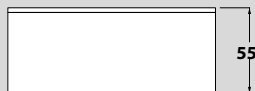

Scheda tecnica disponibile sul sito [www.gruppotres.it](http://www.gruppotres.it)  
 Technical drawing available on [www.gruppotres.it](http://www.gruppotres.it)

## INSTALLAZIONE / INSTALLATION

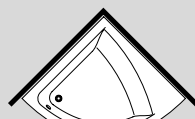

**ANGOLARE**  
TO ANGLE

MODELLO MODEL	ARTICOLO ARTICLE	DESCRIZIONE DESCRIPTION	
<b>VASCA INCASSO - BUILT-IN BATHTUB</b>			
<b>VIN</b>	<b>V4230</b>	<b>INCASSO</b> BUILT-IN	<b>700</b>
<b>VASCA CON TELAIO - BATHTUB WITH FRAME</b>			
<b>VTL</b>	<b>V4231</b>	<b>SENZA IDROMASSAGGIO</b> WITHOUT WHIRLPOOL	<b>1.300</b>
<b>VASCA CON IDROMASSAGGIO - BATHTUB WITH WHIRLPOOL</b>			
<b>PRA</b>	<b>V4232</b>	<b>IDROMASSAGGIO CON AVVIAMENTO PNEUMATICO</b> WHIRLPOOL WITH PNEUMATIC START	<b>2.550</b>

## PANNELLI PER VASCA - PANELS FOR BATHTUB

	<b>V423F</b>	<b>PANNELLO FRONTALE</b> FRONTAL PANEL	<b>300</b>
--	--------------	---	------------

## DOTAZIONI VASCA BATHTUB SUPPLY

	VIN - VTL	PRA
• <b>JET IDROMASSAGGIO</b> - WHIRLPOOL JET	—	6
• <b>JET AIRPOOL</b> - AIRPOOL JET	—	—
• <b>COLONNA DI SCARICO</b> - DRAIN COLUMN	●	●
• <b>SENSORE DI LIVELLO</b> - LEVEL SENSOR	—	●
• <b>MASSIMO CONTENUTO ACQUA</b> - MAX WATER CAPACITY	270 LT.	270 LT.

### LEGENDA - LEGEND

- **Di serie** - Of series
- **Non disponibile** - Not available

	RUBINETTERIA E CUSCINO TAPS AND PILLOW		CROMO CHROME
MIX	<b>MISCELATORE MONOCOMANDO CON DEVIATORE E DOCCETTA</b> SINGLE-LEVER MIXER WITH DIVERTER AND HAND-SHOWER		400
BVP	<b>BOCCA A VELA PICCOLA</b> SMALL SAIL-SHAPED		200
COE	<b>SUPPLEMENTO PER COLONNA DI SCARICO CON EROGAZIONE</b> SURCHARGE POP UP & OVERFLOW WITH WATER OUTLET SPOUT		80
CUS	<b>CUSCINO POGGIATESTA MORBIDO NERO</b> SOFT PILLOW HEADREST BLACK	150	
FOR	<b>SUPPLEMENTO PER FORATURA RUBINETTERIA DIVERSA DA QUELLE PRESENTI SUL NOSTRO LISTINO</b> SURCHARGE FOR TAPS DRILLING IF TAPS ARE NOT OUR MODELS	500	

# Asyx 160 x 90 x 60h

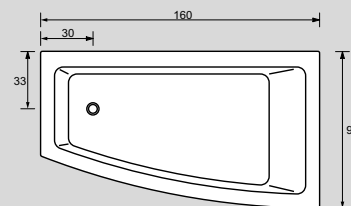
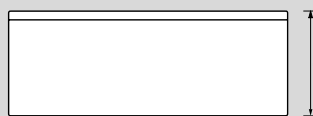

Scheda tecnica disponibile sul sito [www.gruppotes.it](http://www.gruppotes.it)  
 Technical drawing available on [www.gruppotes.it](http://www.gruppotes.it)

## INSTALLAZIONE / INSTALLATION

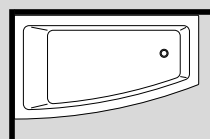

(SX)

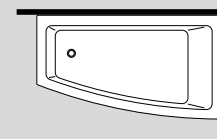

(DX)

MODELLO MODEL	ARTICOLO ARTICLE	DESCRIZIONE DESCRIPTION		
<b>VASCA INCASSO - BUILT-IN BATHTUB</b>				
<b>VIN</b>	<b>V8260</b>	<b>INCASSO BUILT-IN</b>	<b>850</b>	
<b>VASCA CON TELAIO - BATHTUB WITH FRAME</b>				
<b>VTL</b>	<b>V8261</b>	<b>SENZA IDROMASSAGGIO WITHOUT WHIRLPOOL</b>	<b>1.700</b>	
<b>VASCA CON IDROMASSAGGIO - BATHTUB WITH WHIRLPOOL</b>				
<b>STD</b>	<b>STANDARD DIGITALE</b>	<b>V8267</b>	<b>IDROMASSAGGIO CON AVVIAMENTO DIGITALE WHIRLPOOL WITH DIGITAL START</b>	<b>2.700</b>
<b>STX</b>	<b>STANDARD EXTRA</b>	<b>V826B</b>	<b>IDROMASSAGGIO CON IMPIANTO DIGITALE E FARO SUBACQUEO WHIRLPOOL WITH DIGITAL SYSTEM AND UNDERWATER LAMP</b>	<b>3.300</b>
<b>AWA</b>	<b>DIGITAL WHIRLPOOL AIRPOOL</b>	<b>V826N</b>	<b>IDROMASSAGGIO E AIRPOOL CON IMPIANTO DIGITALE E FARO SUBACQUEO WHIRLPOOL AND AIRPOOL WITH DIGITAL SYSTEM AND UNDERWATER LAMP</b>	<b>5.000</b>

## PANNELLI PER VASCA - PANELS FOR BATHTUB

	<b>V826F</b>	<b>PANNELLO FRONTALE FRONTAL PANEL</b>	<b>450</b>
---	--------------	--	------------

DOTAZIONI VASCA BATHTUB SUPPLY	VIN-VTL	STD	STX	AWA
• JET IDROMASSAGGIO - WHIRLPOOL JET	—	6	6	6
• JET AIRPOOL - AIRPOOL JET	—	—	—	12
• COLONNA DI SCARICO - DRAIN COLUMN	●	●	●	●
• SENSORE DI LIVELLO - LEVEL SENSOR	—	●	●	●
• FARO SUBACQUEO - UNDERWATER LAMP	—	—	●	●
• MASSIMO CONTENUTO ACQUA - MAX WATER CAPACITY	195 LT.	195 LT.	195 LT.	195 LT.

**LEGENDA - LEGEND**

- Di serie - Of series
- Non disponibile - Not available

	OPTIONAL VASCA BATHTUB OPTIONALS	STD	STX	AWA
STATA	STABILIZZATORE TEMPERATURA ACQUA - WATER TEMPERATURE STABILIZER	600	600	600
CROMO	CROMOTERAPIA - CHROMOTHERAPY	700	700	700
BORDO	KIT PROFILO BORDO VASCA - BATHTUB EDGE SKIRTING KIT	50	50	50
078CU	CUSCINO POGGIATESTA MORBIDO (NERO*) - SOFT PILLOW HEADREST (BLACK*)	150	150	150
FINOR	SUPPLEMENTO PER FINITURE ORO - SURCHARGE FOR GOLDEN FINISH	300	300	300

\* Disponibile su richiesta anche bianco / Available on request also in white

	RUBINETTERIA TAPS		CROMO CHROME	ORO GOLD
MIX	MISCELATORE MONOCOMANDO CON DEVIATORE E DOCCETTA SINGLE-LEVER MIXER WITH DIVERTER AND HAND-SHOWER		400	650
MLQ	MISCELATORE MONOCOMANDO QUADRATO CON DEVIATORE E DOCCETTA SQUARED SINGLE-LEVER MIXER WITH DIVERTER AND HAND-SHOWER		500	800
LINE	RUBINETTERIA ACQUA CALDA ACQUA FREDDA CON DEVIATORE E DOCCETTA SEMI-INCASSO HOT/COLD WATER TAPS WITH DIVERTER AND SEMI-BUILT IN HAND SHOWER		1.000	—
RUE	RUBINETTERIA ELETTRONICA CON DEVIATORE E DOCCETTA SEMI-INCASSO ELECTRONIC WATER TAPS WITH DIVERTER AND SEMI-BUILT IN HAND SHOWER		1.500	—
BVP	BOCCA A VELA PICCOLA SMALL SAIL-SHAPED		200	—
BVC	BOCCA A VELA PICCOLA MODELLO CUBO SMALL SAIL-SHAPED CUBO MODEL		200	—
COE	SUPPLEMENTO PER COLONNA DI SCARICO CON EROGAZIONE SURCHARGE FOR DRAIN COLUMN WITH WATER OUTLET		80	100
SIF	SIFONE SCARICO VASCA PLASTIC SIPHON	40		
FOR	SUPPLEMENTO PER FORATURA RUBINETTERIA DIVERSA DA QUELLE PRESENTI SUL NOSTRO LISTINO SURCHARGE FOR TAPS DRILLING IF TAPS ARE NOT OUR MODELS	500		

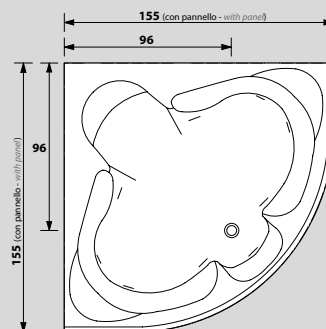
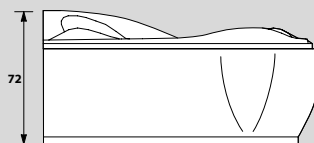

Scheda tecnica disponibile sul sito [www.gruppotes.it](http://www.gruppotes.it)  
 Technical drawing available on [www.gruppotes.it](http://www.gruppotes.it)

## INSTALLAZIONE / INSTALLATION

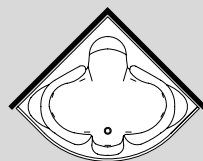

ANGOLARE - TO ANGLE

MODELLO MODEL	ARTICOLO ARTICLE	DESCRIZIONE DESCRIPTION		
<b>VASCA INCASSO - BUILT-IN BATHTUB</b>				
<b>VIN</b>	<b>V7450</b>	<b>INCASSO BUILT-IN</b>	<b>1.450</b>	
<b>VASCA CON TELAIO - BATHTUB WITH FRAME</b>				
<b>VTL</b>	<b>V7451</b>	<b>SENZA IDROMASSAGGIO WITHOUT WHIRLPOOL</b>	<b>1.800</b>	
<b>VASCA CON IDROMASSAGGIO - BATHTUB WITH WHIRLPOOL</b>				
<b>STD</b>	<b>STANDARD DIGITALE</b>	<b>V7457</b>	<b>IDROMASSAGGIO CON AVVIAMENTO DIGITALE WHIRLPOOL WITH DIGITAL START</b>	<b>3.550</b>
<b>STX</b>	<b>STANDARD EXTRA</b>	<b>V745B</b>	<b>IDROMASSAGGIO CON IMPIANTO DIGITALE E FARO SUBACQUEO WHIRLPOOL WITH DIGITAL SYSTEM AND UNDERWATER LAMP</b>	<b>4.150</b>
<b>AWA</b>	<b>DIGITAL WHIRLPOOL AIRPOOL</b>	<b>V745N</b>	<b>IDROMASSAGGIO E AIRPOOL CON IMPIANTO DIGITALE E FARO SUBACQUEO WHIRLPOOL AND AIRPOOL WITH DIGITAL SYSTEM AND UNDERWATER LAMP</b>	<b>5.950</b>

## PANNELLI PER VASCA - PANELS FOR BATHTUB

	<b>V745F</b>	<b>PANNELLO FRONTALE FRONTAL PANEL</b>	<b>350</b>
--	--------------	--	------------

<b>DOTAZIONI VASCA</b> BATHTUB SUPPLY	<b>VIN-VTL</b>	<b>STD</b>	<b>STX</b>	<b>AWA</b>
• <b>JET IDROMASSAGGIO</b> - WHIRLPOOL JET	—	8	8	8
• <b>JET AIRPOOL</b> - AIRPOOL JET	—	—	—	18
• <b>COLONNA DI SCARICO</b> - DRAIN COLUMN	●	●	●	●
• <b>FARO SUBACQUEO</b> - UNDERWATER LAMP	—	—	●	●
• <b>EROGAZIONE ACQUA CON CASCATA</b> - WATER JET WITH CASCADE	●	●	●	●
• <b>MISCELATORE MONOCOMANDO CON DEVIATORE E DOCCETTA</b> - SINGLE-LEVER MIXER WITH DIVERTER AND SHOWER-HEAD	●	●	●	●
• <b>SENSORE DI LIVELLO</b> - LEVEL SENSOR	●	●	●	●
• <b>MASSIMO CONTENUTO ACQUA</b> - MAX WATER CAPACITY	280 LT.	280 LT.	280 LT.	280 LT.

**LEGENDA** - LEGEND

- **Di serie** - Of series
- **Non disponibile** - Not available

	<b>OPTIONAL VASCA</b> BATHTUB OPTIONALS	<b>STD</b>	<b>STX</b>	<b>AWA</b>
<b>STATA</b>	<b>STABILIZZATORE TEMPERATURA ACQUA</b> - WATER TEMPERATURE STABILIZER	600	600	600
<b>CROMO</b>	<b>CROMOTERAPIA</b> - CHROMOTHERAPY	700	700	700
<b>BORDOM</b>	<b>KIT PROFILO BORDO VASCA MORBIDO</b> - BATHTUB SOFT EDGE SKIRTING KIT	50	50	50
<b>FINOR</b>	<b>SUPPLEMENTO PER FINITURE ORO</b> - SURCHARGE FOR GOLDEN FINISH	300	300	300

	<b>RUBINETTERIA</b> TAPS		<b>CROMO</b> CHROME
<b>RUE</b>	<b>SUPPLEMENTO RUBINETTERIA ELETTRONICA CON DEVIATORE E DOCCETTA SEMI-INCASSO</b> SURCHARGE ELECTRONIC WATER TAPS WITH DIVERTER AND SEMI-BUILT IN HAND SHOWER		1.100
<b>SIF</b>	<b>SIFONE SCARICO VASCA</b> PLASTIC SIPHON	40	
<b>FOR</b>	<b>SUPPLEMENTO PER FORATURA RUBINETTERIA DIVERSA DA QUELLE PRESENTI SUL NOSTRO LISTINO</b> SURCHARGE FOR TAPS DRILLING IF TAPS ARE NOT OUR MODELS	500	

# Matrix Slim 170 x 138 x 72h

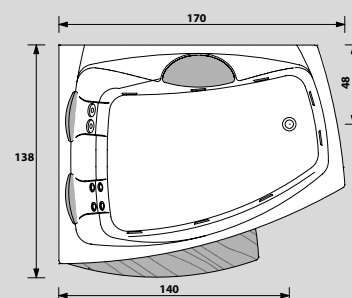
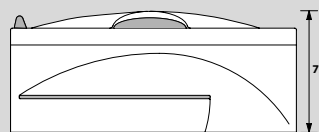

Scheda tecnica disponibile sul sito [www.gruppotres.it](http://www.gruppotres.it)  
 Technical drawing available on [www.gruppotres.it](http://www.gruppotres.it)

## INSTALLAZIONE / INSTALLATION

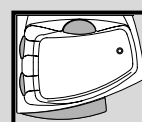

1(SX)

MODELLO MODEL	ARTICOLO ARTICLE	DESCRIZIONE DESCRIPTION		
<b>VASCA CON TELAIO - BATHTUB WITH FRAME</b>				
<b>VTL</b>	<b>V7631</b>	<b>SENZA IDROMASSAGGIO WITHOUT WHIRLPOOL</b>	<b>2.100</b>	
<b>VASCA CON IDROMASSAGGIO - BATHTUB WITH WHIRLPOOL</b>				
<b>STD</b>	<b>STANDARD DIGITALE</b>	<b>V7637</b>	<b>IDROMASSAGGIO CON AVVIAMENTO DIGITALE WHIRLPOOL WITH DIGITAL START</b>	<b>4.600</b>
<b>STX</b>	<b>STANDARD EXTRA</b>	<b>V763B</b>	<b>IDROMASSAGGIO CON IMPIANTO DIGITALE E FARO SUBACQUEO WHIRLPOOL WITH DIGITAL SYSTEM AND UNDERWATER LAMP</b>	<b>5.200</b>
<b>AWA</b>	<b>DIGITAL WHIRLPOOL AIRPOOL</b>	<b>V763N</b>	<b>IDROMASSAGGIO E AIRPOOL CON IMPIANTO DIGITALE E FARO SUBACQUEO WHIRLPOOL AND AIRPOOL WITH DIGITAL SYSTEM AND UNDERWATER LAMP</b>	<b>6.900</b>

## PANNELLI PER VASCA - PANELS FOR BATHTUB

	<b>V763F</b>	<b>PANNELLO FRONTALE COMPLETO DI GRADINO RIVESTITO IN LEGNO FRONTAL PANEL COMPLETE OF WOOD COVERING STEP</b>	<b>450</b>
	<b>V763L D</b>	<b>PANNELLO LATERALE SIDE PANEL</b>	<b>300</b>

DOTAZIONI VASCA BATHTUB SUPPLY	VTL	STD	STX	AWA
• JET IDROMASSAGGIO - WHIRLPOOL JET	—	14	14	14
• JET AIRPOOL - AIRPOOL JET	—	—	—	20
• EROGAZIONE ACQUA CON CASCATA - WATER JETS WITH CASCADE	●	●	●	●
• CUSCINO POGGIATESTA BLU* - BLUE HEADREST*	2	2	2	2
• FARO SUBACQUEO - UNDERWATER LAMP	—	—	●	●
• SEDILE BLU* - BLUE SEAT*	●	●	●	●
• MISCELATORE MONOCOMANDO CON DEVIATORE E DOCCETTA - SINGLE-LEVER MIXER WITH DIVERTER AND SHOWER-HEAD	●	●	●	●
• SENSORE DI LIVELLO - LEVEL SENSOR	—	●	●	●
• COLONNA DI SCARICO - DRAIN COLUMN	●	●	●	●
• MASSIMO CONTENUTO ACQUA - MAX WATER CAPACITY	300 LT.	300 LT.	300 LT.	300 LT.

\* Disponibile su richiesta anche bianco

\* Available on request also in white

LEGENDA - LEGEND

● Di serie - Of series

— Non disponibile - Not available

	OPTIONAL VASCA BATHTUB OPTIONALS	STD	STX	AWA
STATA	STABILIZZATORE TEMPERATURA ACQUA - WATER TEMPERATURE STABILIZER	600	600	600
CROMO	CROMOTERAPIA - CHROMOTHERAPY	700	700	700
BORDOM	KIT PROFILO BORDO VASCA MORBIDO - BATHTUB SOFT EDGE SKIRTING KIT	50	50	50
FINOR	SUPPLEMENTO PER FINITURE ORO - SURCHARGE FOR GOLDEN FINISH	300	300	300

	RUBINETTERIA TAPS		CROMO CHROME
RUE	SUPPLEMENTO RUBINETTERIA ELETTRONICA CON DEVIATORE E DOCCETTA SEMI-INCASSO SURCHARGE ELECTRONIC WATER TAPS WITH DIVERTER AND SEMI-BUILT IN HAND SHOWER		1.100
SIF	SIFONE SCARICO VASCA PLASTIC SIPHON	40	
FOR	SUPPLEMENTO PER FORATURA RUBINETTERIA DIVERSA DA QUELLE PRESENTI SUL NOSTRO LISTINO SURCHARGE FOR TAPS DRILLING IF TAPS ARE NOT OUR MODELS	500	

# Slide 140 x 140 x 66h

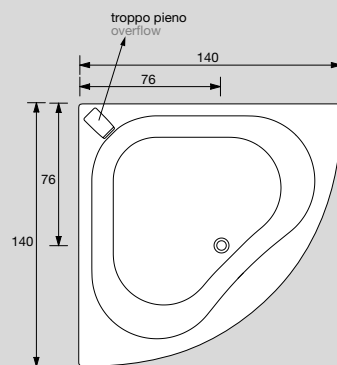
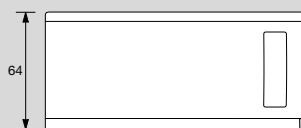

Scheda tecnica disponibile sul sito [www.gruppotes.it](http://www.gruppotes.it)  
Technical drawing available on [www.gruppotes.it](http://www.gruppotes.it)

## INSTALLAZIONE / INSTALLATION

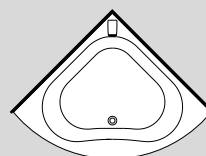

ANGOLARE - TO ANGLE

MODELLO MODEL	ARTICOLO ARTICLE	DESCRIZIONE DESCRIPTION		
<b>VASCA INCASSO - BUILT-IN BATHTUB</b>				
<b>VIN</b>	<b>V0440</b>	<b>INCASSO BUILT-IN</b>	<b>1.250</b>	
<b>VASCA CON TELAIO - BATHTUB WITH FRAME</b>				
<b>VTL</b>	<b>V0441</b>	<b>SENZA IDROMASSAGGIO WITHOUT WHIRLPOOL</b>	<b>1.600</b>	
<b>VASCA CON IDROMASSAGGIO - BATHTUB WITH WHIRLPOOL</b>				
<b>STD</b>	<b>STANDARD DIGITALE</b>	<b>V0447</b>	<b>IDROMASSAGGIO CON AVVIAMENTO DIGITALE WHIRLPOOL WITH DIGITAL START</b>	<b>3.200</b>
<b>STX</b>	<b>STANDARD EXTRA</b>	<b>V044B</b>	<b>IDROMASSAGGIO CON IMPIANTO DIGITALE E FARO SUBACQUEO WHIRLPOOL WITH DIGITAL SYSTEM AND UNDERWATER LAMP</b>	<b>3.950</b>

## PANNELLI PER VASCA - PANELS FOR BATHTUB

	<b>V044F</b>	<b>PANNELLO FRONTALE CON LUCE DI CORTESIA FRONTAL PANEL WITH LIGHT</b>	<b>600</b>
--	--------------	--	------------

**N.B.:** per il funzionamento della luce occorre predisporre un interruttore a muro / for the operation of light, it is necessary to manage one wall switch

DOTAZIONI VASCA BATHTUB SUPPLY	VIN-VTL	STD	STX
• JET IDROMASSAGGIO - WHIRLPOOL JET	—	7	7
• JET AIRPOOL - AIRPOOL JET	—	—	—
• FARO SUBACQUEO - UNDERWATER LAMP	—	—	●
• COLONNA DI SCARICO - DRAIN COLUMN	●	●	●
• SENSORE DI LIVELLO - LEVEL SENSOR	—	●	●
• MASSIMO CONTENUTO ACQUA - MAX WATER CAPACITY	390 LT.	390 LT.	390 LT.

**LEGENDA - LEGEND**

- Di serie - Of series
- Non disponibile - Not available

	OPTIONAL VASCA BATHTUB OPTIONALS	STD	STX
STATA	STABILIZZATORE TEMPERATURA ACQUA - WATER TEMPERATURE STABILIZER	600	600
CROMO	CROMOTERAPIA - CHROMOTHERAPY	700	700
BORDO	KIT PROFILO BORDO VASCA - BATHTUB EDGE SKIRTING KIT	50	50

	RUBINETTERIA TAPS		CROMO CHROME
MIX	MISCELATORE MONOCOMANDO CON DEVIATORE E DOCCETTA SINGLE-LEVER MIXER WITH DIVERTER AND HAND-SHOWER		400
MLQ	MISCELATORE MONOCOMANDO QUADRATO CON DEVIATORE E DOCCETTA SQUARED SINGLE-LEVER MIXER WITH DIVERTER AND HAND-SHOWER		500
ERF	RIEMPIMENTO VASCA DAL FONDO FILLING BATHTUB FROM THE BOTTOM		250
BEA	N°2 BOCHE EROGAZIONE CON AERATORE N°2 FIXED SPOUT WITH AERATOR		200
RUE	RUBINETTERIA ELETTRONICA CON DEVIATORE E DOCCETTA SEMI-INCASSO ELECTRONIC WATER TAPS WITH DIVERTER AND SEMI-BUILT IN HAND SHOWER		1.500
SIF	SIFONE SCARICO VASCA PLASTIC SIPHON	40	
FOR	SUPPLEMENTO PER FORATURA RUBINETTERIA DIVERSA DA QUELLE PRESENTI SUL NOSTRO LISTINO SURCHARGE FOR TAPS DRILLING IF TAPS ARE NOT OUR MODELS	500	

**BEA**
**BOCCA EROGAZIONE CON AERATORE**  
 FIXED SPOUT WITH AERATOR

# Suri 175

175 x 100 x 57h

(WhiVe®) bianco opaco (matt white)

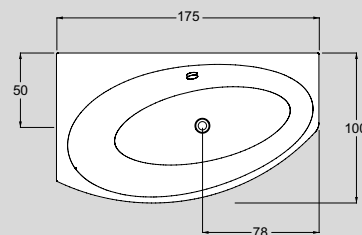

Scheda tecnica disponibile sul sito [www.gruppotes.it](http://www.gruppotes.it)  
 Technical drawing available on [www.gruppotes.it](http://www.gruppotes.it) web site

## INSTALLAZIONE / INSTALLATION

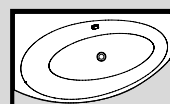

(SX)

MODELLO MODEL	ARTICOLO ARTICLE	DESCRIZIONE DESCRIPTION		
<b>VASCA INCASSO - BUILT-IN BATHTUB</b>				
<b>VIN</b>	<b>V2750</b>	<b>INCASSO BUILT-IN</b>	<b>1.150</b>	
<b>VASCA CON TELAIO - BATHTUB WITH FRAME</b>				
<b>VTL</b>	<b>V2751</b>	<b>SENZA IDROMASSAGGIO WITHOUT WHIRLPOOL</b>	<b>1.950</b>	
<b>VASCA CON IDROMASSAGGIO - BATHTUB WITH WHIRLPOOL</b>				
<b>STD</b>	<b>STANDARD DIGITALE</b>	<b>V2757</b>	<b>IDROMASSAGGIO CON AVVIAMENTO DIGITALE WHIRLPOOL WITH DIGITAL START</b>	<b>2.400</b>
<b>STX</b>	<b>STANDARD EXTRA</b>	<b>V275B</b>	<b>IDROMASSAGGIO CON IMPIANTO DIGITALE E FARO SUBACQUEO WHIRLPOOL WITH DIGITAL CONTROL AND UNDERWATER LAMP</b>	<b>2.900</b>
<b>AWA</b>	<b>DIGITAL WHIRLPOOL AIRPOOL</b>	<b>V275N</b>	<b>IDROMASSAGGIO E AIRPOOL CON IMPIANTO DIGITALE E FARO SUBACQUEO WHIRLPOOL AND AIRPOOL WITH DIGITAL CONTROL AND UNDERWATER LAMP</b>	<b>4.600</b>

## PANNELLI PER VASCA - BATHTUB PANELS

	<b>V275F</b>	<b>PANNELLO PANEL</b>	<b>950</b>
---	--------------	---------------------------	------------

<b>DOTAZIONI VASCA BATHTUB SUPPLY</b>	<b>VIN-VTL</b>	<b>STD</b>	<b>STX</b>	<b>AWA</b>
• <b>JET IDROMASSAGGIO - WHIRLPOOL JET</b>	—	6	6	6
• <b>JET AIRPOOL - AIRPOOL JET</b>	—	—	—	12
• <b>FARO SUBACQUEO - UNDERWATER LAMP</b>	—	—	●	●
• <b>COLONNA DI SCARICO - DRAIN COLUMN</b>	●	●	●	●
• <b>SENSORE DI LIVELLO - LEVEL SENSOR</b>	●	●	●	●
• <b>MASSIMO CONTENUTO ACQUA - MAX WATER CAPACITY</b>	240 LT.	240 LT.	240 LT.	240 LT.

**LEGENDA - LEGEND**

- **Di serie - Of series**
- **Non disponibile - Not available**

	<b>OPTIONAL VASCA BATHTUB OPTIONALS</b>	<b>STD</b>	<b>STX</b>	<b>AWA</b>
<b>STATA</b>	<b>STABILIZZATORE TEMPERATURA ACQUA - WATER TEMPERATURE STABILIZER</b>	<b>600</b>	<b>600</b>	<b>600</b>
<b>CROMO</b>	<b>CROMOTERAPIA - CHROMOTHERAPY</b>	<b>700</b>	<b>700</b>	<b>700</b>

	<b>RUBINETTERIA TAPS</b>		<b>CROMO CHROME</b>
<b>MIX</b>	<b>SUPPLEMENTO PER MISCELATORE MONOCOMANDO CON DEVIATORE E DOCCETTA SURCHARGE FOR SINGLE-LEVER MIXER WITH DIVERTER AND HAND-SHOWER</b>		<b>400</b>
<b>BVP</b>	<b>BOCCA A VELA PICCOLA SMALL SAIL-SHAPED</b>		<b>200</b>
<b>COE</b>	<b>SUPPLEMENTO PER COLONNA DI SCARICO CON EROGAZIONE SURCHARGE FOR DRAIN COLUMN WITH WATER OUTLET</b>		<b>80</b>
<b>SIF</b>	<b>SIFONE SCARICO VASCA PLASTIC SIPHON</b>	<b>40</b>	
<b>FOR</b>	<b>SUPPLEMENTO PER FORATURA RUBINETTERIA DIVERSA DA QUELLE PRESENTI SUL NOSTRO LISTINO SURCHARGE FOR TAPS DRILLING IF TAPS ARE NOT OUR MODELS</b>	<b>500</b>	



# Vasche rettangolari

## *Rectangular bathtubs*

21

<b>APP 160</b>	22
<b>APP 170</b>	24
<b>APP 180</b>	26
<b>CLIZIA 105-120</b>	28
<b>CLIZIA</b>	30
<b>PLAYA</b>	32
<b>SURI 170</b>	34
<b>BLANQUE 1690</b>	36
<b>BLANQUE 1810</b>	38
<b>BLANQUE 1880</b>	40
<b>BLANQUE 1915</b>	42
<b>PERLA</b>	44

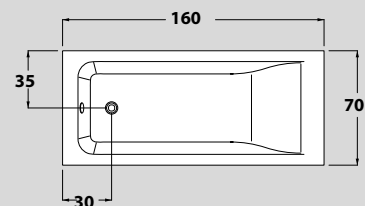
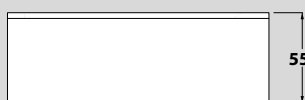

Scheda tecnica disponibile sul sito [www.gruppotes.it](http://www.gruppotes.it)  
 Technical drawing available on [www.gruppotes.it](http://www.gruppotes.it)

## INSTALLAZIONE / INSTALLATION

DISPONIBILE ANCHE NELLE VERSIONI: 3 - 4 - 5 - 6 - 7 - 8 (RIFERIMENTO PAG. 2)

AVAILABLE ALSO IN VERSIONS: 3 - 4 - 5 - 6 - 7 - 8 (REF. PAGE 2)

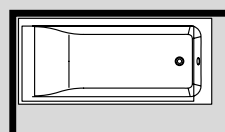

1(SX)

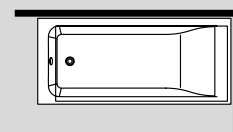

2(DX)

MODELLO MODEL	ARTICOLO ARTICLE	DESCRIZIONE DESCRIPTION	
<b>VASCA INCASSO - BUILT-IN BATHTUB</b>			
<b>VIN</b>	<b>V4260</b>	<b>INCASSO BUILT-IN</b>	<b>600</b>
<b>VASCA CON TELAIO - BATHTUB WITH FRAME</b>			
<b>VTL</b>	<b>V4261</b>	<b>SENZA IDROMASSAGGIO WITHOUT WHIRLPOOL</b>	<b>850</b>
<b>VASCA CON IDROMASSAGGIO - BATHTUB WITH WHIRLPOOL</b>			
<b>PRA</b>	<b>V4262</b>	<b>IDROMASSAGGIO CON AVVIAMENTO PNEUMATICO WHIRLPOOL WITH PNEUMATIC START</b>	<b>2.100</b>

## PANNELLI PER VASCA - PANELS FOR BATHTUB

	<b>V426F</b>	<b>PANNELLO FRONTALE FRONTAL PANEL</b>	<b>300</b>
	<b>V427L D/S</b>	<b>PANNELLO LATERALE DESTRO O SINISTRO RIGHT OR LEFT SIDE PANEL</b>	<b>250</b>

<b>DOTAZIONI VASCA</b> BATHTUB SUPPLY	<b>VIN-VTL</b>	<b>PRA</b>
• <b>JET IDROMASSAGGIO</b> - WHIRLPOOL JET	—	6
• <b>JET AIRPOOL</b> - AIRPOOL JET	—	—
• <b>COLONNA DI SCARICO</b> - DRAIN COLUMN	●	●
• <b>SENSORE DI LIVELLO</b> - LEVEL SENSOR	—	●
• <b>MASSIMO CONTENUTO ACQUA</b> - MAX WATER CAPACITY	180 LT.	180 LT.

**LEGENDA - LEGEND**

- **Di serie** - Of series
- **Non disponibile** - Not available

	<b>RUBINETTERIA E CUSCINO</b> TAPS AND PILLOW		<b>CROMO</b> CHROME
<b>MIX</b>	<b>MISCELATORE MONOCOMANDO CON DEVIATORE E DOCCETTA</b> SINGLE-LEVER MIXER WITH DIVERTER AND HAND-SHOWER		<b>400</b>
<b>BVP</b>	<b>BOCCA A VELA PICCOLA</b> SMALL SAIL-SHAPED		<b>200</b>
<b>COE</b>	<b>SUPPLEMENTO PER COLONNA DI SCARICO CON EROGAZIONE</b> SURCHARGE POP UP & OVERFLOW WITH WATER OUTLET SPOUT		<b>80</b>
<b>CUS</b>	<b>CUSCINO POGGIATESTA MORBIDO NERO</b> SOFT PILLOW HEADREST BLACK	<b>150</b>	
<b>FOR</b>	<b>SUPPLEMENTO PER FORATURA RUBINETTERIA DIVERSA DA QUELLE PRESENTI SUL NOSTRO LISTINO</b> SURCHARGE FOR TAPS DRILLING IF TAPS ARE NOT OUR MODELS	<b>500</b>	

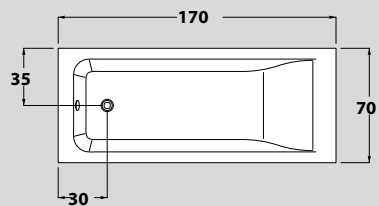
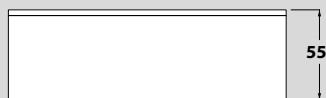

Scheda tecnica disponibile sul sito [www.gruppotes.it](http://www.gruppotes.it)  
 Technical drawing available on [www.gruppotes.it](http://www.gruppotes.it)

**INSTALLAZIONE / INSTALLATION**

**DISPONIBILE ANCHE NELLE VERSIONI: 3 - 4 - 5 - 6 - 7 - 8 (RIFERIMENTO PAG. 2)**  
 AVAILABLE ALSO IN VERSIONS: 3 - 4 - 5 - 6 - 7 - 8 (REF. PAGE 2)

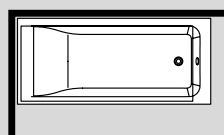

**1(SX)**

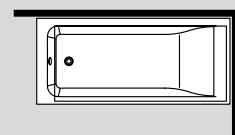

**2(DX)**

MODELLO MODEL	ARTICOLO ARTICLE	DESCRIZIONE DESCRIPTION	
<b>VASCA INCASSO - BUILT-IN BATHTUB</b>			
<b>VIN</b>	<b>V4270</b>	<b>INCASSO BUILT-IN</b>	<b>600</b>
<b>VASCA CON TELAIO - BATHTUB WITH FRAME</b>			
<b>VTL</b>	<b>V4271</b>	<b>SENZA IDROMASSAGGIO WITHOUT WHIRLPOOL</b>	<b>850</b>
<b>VASCA CON IDROMASSAGGIO - BATHTUB WITH WHIRLPOOL</b>			
<b>PRA</b>	<b>V4272</b>	<b>IDROMASSAGGIO CON AVVIAMENTO PNEUMATICO WHIRLPOOL WITH PNEUMATIC START</b>	<b>2.100</b>

<b>PANNELLI PER VASCA - PANELS FOR BATHTUB</b>			
	<b>V427F</b>	<b>PANNELLO FRONTALE FRONTAL PANEL</b>	<b>300</b>
	<b>V427L D/S</b>	<b>PANNELLO LATERALE DESTRO O SINISTRO RIGHT OR LEFT SIDE PANEL</b>	<b>250</b>

**DOTAZIONI VASCA**  
**BATHTUB SUPPLY**

	VIN-VTL	PRA
• <b>JET IDROMASSAGGIO</b> - WHIRLPOOL JET	—	6
• <b>JET AIRPOOL</b> - AIRPOOL JET	—	—
• <b>COLONNA DI SCARICO</b> - DRAIN COLUMN	●	●
• <b>SENSORE DI LIVELLO</b> - LEVEL SENSOR	—	●
• <b>MASSIMO CONTENUTO ACQUA</b> - MAX WATER CAPACITY	220 LT.	220 LT.

**LEGENDA** - LEGEND

- **Di serie** - Of series
- **Non disponibile** - Not available

	RUBINETTERIA E CUSCINO		CROMO
	TAPS AND PILLOW		CHROME
<b>MIX</b>	<b>MISCELATORE MONOCOMANDO CON DEVIATORE E DOCCETTA</b> SINGLE-LEVER MIXER WITH DIVERTER AND HAND-SHOWER		<b>400</b>
<b>BVP</b>	<b>BOCCA A VELA PICCOLA</b> SMALL SAIL-SHAPED		<b>200</b>
<b>COE</b>	<b>SUPPLEMENTO PER COLONNA DI SCARICO CON EROGAZIONE</b> SURCHARGE POP UP & OVERFLOW WITH WATER OUTLET SPOUT		<b>80</b>
<b>CUS</b>	<b>CUSCINO POGGIATESTA MORBIDO NERO</b> SOFT PILLOW HEADREST BLACK	<b>150</b>	
<b>FOR</b>	<b>SUPPLEMENTO PER FORATURA RUBINETTERIA DIVERSA DA QUELLE PRESENTI SUL NOSTRO LISTINO</b> SURCHARGE FOR TAPS DRILLING IF TAPS ARE NOT OUR MODELS	<b>500</b>	

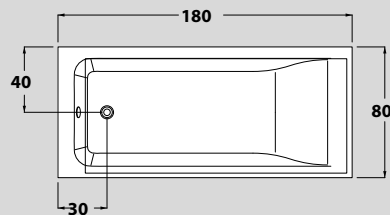
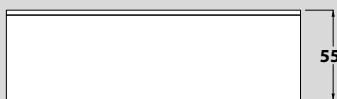

Scheda tecnica disponibile sul sito [www.gruppotes.it](http://www.gruppotes.it)  
 Technical drawing available on [www.gruppotes.it](http://www.gruppotes.it)

**INSTALLAZIONE / INSTALLATION**

**DISPONIBILE ANCHE NELLE VERSIONI: 3 - 4 - 5 - 6 - 7 - 8 (RIFERIMENTO PAG. 2)**  
 AVAILABLE ALSO IN VERSIONS: 3 - 4 - 5 - 6 - 7 - 8 (REF. PAGE 2)

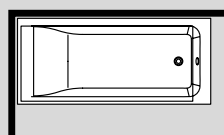

**1(SX)**

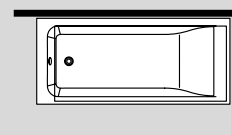

**2(DX)**

MODELLO MODEL	ARTICOLO ARTICLE	DESCRIZIONE DESCRIPTION	
<b>VASCA INCASSO - BUILT-IN BATHTUB</b>			
<b>VIN</b>	<b>V4280</b>	<b>INCASSO BUILT-IN</b>	<b>650</b>
<b>VASCA CON TELAIO - BATHTUB WITH FRAME</b>			
<b>VTL</b>	<b>V4281</b>	<b>SENZA IDROMASSAGGIO WITHOUT WHIRLPOOL</b>	<b>950</b>
<b>VASCA CON IDROMASSAGGIO - BATHTUB WITH WHIRLPOOL</b>			
<b>PRA</b>	<b>V4282</b>	<b>IDROMASSAGGIO CON AVVIAMENTO PNEUMATICO WHIRLPOOL WITH PNEUMATIC START</b>	<b>2.400</b>

**PANNELLI PER VASCA - PANELS FOR BATHTUB**

	<b>V428F</b>	<b>PANNELLO FRONTALE FRONTAL PANEL</b>	<b>300</b>
	<b>V428L D/S</b>	<b>PANNELLO LATERALE DESTRO O SINISTRO RIGHT OR LEFT SIDE PANEL</b>	<b>250</b>

<b>DOTAZIONI VASCA</b> BATHTUB SUPPLY	<b>VIN-VTL</b>	<b>PRA</b>
• <b>JET IDROMASSAGGIO</b> - WHIRLPOOL JET	—	6
• <b>JET AIRPOOL</b> - AIRPOOL JET	—	—
• <b>COLONNA DI SCARICO</b> - DRAIN COLUMN	●	●
• <b>SENSORE DI LIVELLO</b> - LEVEL SENSOR	—	●
• <b>MASSIMO CONTENUTO ACQUA</b> - MAX WATER CAPACITY	260 LT.	260 LT.

**LEGENDA - LEGEND**

- **Di serie** - Of series
- **Non disponibile** - Not available

	<b>RUBINETTERIA E CUSCINO</b> TAPS AND PILLOW		<b>CROMO</b> CHROME
<b>MIX</b>	<b>MISCELATORE MONOCOMANDO CON DEVIATORE E DOCCETTA</b> SINGLE-LEVER MIXER WITH DIVERTER AND HAND-SHOWER		<b>400</b>
<b>BVP</b>	<b>BOCCA A VELA PICCOLA</b> SMALL SAIL-SHAPED		<b>200</b>
<b>COE</b>	<b>SUPPLEMENTO PER COLONNA DI SCARICO CON EROGAZIONE</b> SURCHARGE POP UP & OVERFLOW WITH WATER OUTLET SPOUT		<b>80</b>
<b>CUS</b>	<b>CUSCINO POGGIATESTA MORBIDO NERO</b> SOFT PILLOW HEADREST BLACK	<b>150</b>	
<b>FOR</b>	<b>SUPPLEMENTO PER FORATURA RUBINETTERIA DIVERSA DA QUELLE PRESENTI SUL NOSTRO LISTINO</b> SURCHARGE FOR TAPS DRILLING IF TAPS ARE NOT OUR MODELS	<b>500</b>	

# Clizia 105-120

105 x 70 x 52h - 120 x 70 x 56h - 120 x 70 x 56h



**CLIZIA 105:** 105x70x h52 CON SEDILE/WITH SEAT

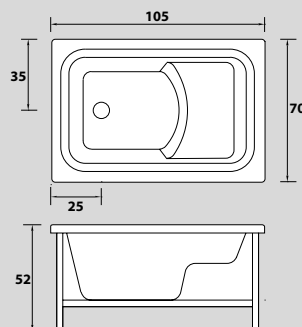

Scheda tecnica disponibile sul sito [www.gruppotes.it](http://www.gruppotes.it)  
Technical drawing available on [www.gruppotes.it](http://www.gruppotes.it)



**CLIZIA 120A:** 120x70x h56

## INSTALLAZIONE / INSTALLATION

**INCASSO\***

BUILT-IN\*

**\*I pannelli non sono previsti**

Panels are not envisioned

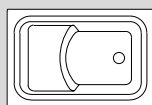

## INSTALLAZIONE / INSTALLATION

**INCASSO\***

BUILT-IN\*

**\*I pannelli non sono previsti**

Panels are not envisioned

MODELLO MODEL	ARTICOLO ARTICLE	DESCRIZIONE DESCRIPTION	
<b>VASCA INCASSO - BUILT-IN BATHTUB</b>			
<b>VIN</b>	<b>V6305</b>	<b>VASCA 105 INCASSO</b> BUILT-IN BATHTUB 105	<b>350</b>
<b>VIN</b>	<b>V6310</b>	<b>VASCA 120 A INCASSO</b> BUILT-IN BATHTUB 120 A	<b>500</b>
<b>VIN</b>	<b>V6310S</b>	<b>VASCA 120 B INCASSO</b> BUILT-IN BATHTUB 120 B	<b>500</b>
<b>VASCA CON TELAIO - BATHTUB WITH FRAME</b>			
<b>VTL</b>	<b>V6315</b>	<b>VASCA 105 SENZA IDROMASSAGGIO</b> BATHTUB 105 WITHOUT WHIRLPOOL	<b>700</b>
<b>VTL</b>	<b>V6311</b>	<b>VASCA 120 A SENZA IDROMASSAGGIO</b> BATHTUB 120 A WITHOUT WHIRLPOOL	<b>700</b>
<b>VTL</b>	<b>V6311S</b>	<b>VASCA 120 B SENZA IDROMASSAGGIO</b> BATHTUB 120 B WITHOUT WHIRLPOOL	<b>700</b>
<b>VASCA CON IDROMASSAGGIO - BATHTUB WITH WHIRLPOOL</b>			
<b>PRA</b>	<b>V6322</b>	<b>VASCA 105 IDROMASSAGGIO CON AVVIAMENTO PNEUMATICO</b> BATHTUB 105 WHIRLPOOL WITH PNEUMATIC START	<b>1.600</b>
<b>PRA</b>	<b>V6312</b>	<b>VASCA 120 A IDROMASSAGGIO CON AVVIAMENTO PNEUMATICO</b> BATHTUB 120 A WHIRLPOOL WITH PNEUMATIC START	<b>1.600</b>

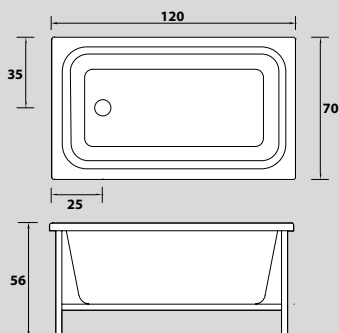

Scheda tecnica disponibile sul sito [www.gruppotes.it](http://www.gruppotes.it)  
 Technical drawing available on [www.gruppotes.it](http://www.gruppotes.it)



**CLIZIA 120B: 120x70x h56 CON SEDILE/WITH SEAT**

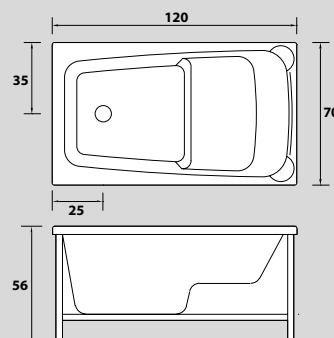

Scheda tecnica disponibile sul sito [www.gruppotes.it](http://www.gruppotes.it)  
 Technical drawing available on [www.gruppotes.it](http://www.gruppotes.it)

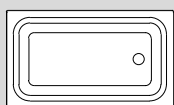

## INSTALLAZIONE / INSTALLATION

**INCASSO\***  
**BUILT-IN\***

**\*I pannelli non sono previsti**  
**Panels are not envisioned**

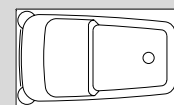

### DOTAZIONI VASCA 105 BATHTUB 105 SUPPLY

	VIN	VTL	PRA
• JET IDROMASSAGGIO - WHIRLPOOL JET	—	—	4
• COLONNA DI SCARICO - DRAIN COLUMN	●	●	●
• MASSIMO CONTENUTO ACQUA - MAX WATER CAPACITY	60 LT.	60 LT.	60 LT.

### DOTAZIONI VASCA 120 A-B BATHTUB 120 A-B SUPPLY

	VIN	VTL	PRA
• JET IDROMASSAGGIO - WHIRLPOOL JET	—	—	5
• COLONNA DI SCARICO - DRAIN COLUMN	●	●	●
• MASSIMO CONTENUTO ACQUA - MAX WATER CAPACITY	85 LT. 75 LT.	85 LT. 75 LT.	85 LT. 75 LT.

#### LEGENDA - LEGEND

- Di serie - Of series
- Non disponibile - Not available

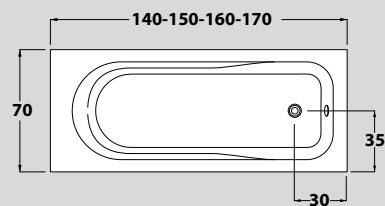
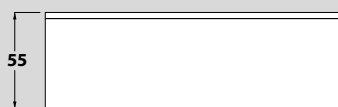

Scheda tecnica disponibile sul sito [www.gruppotres.it](http://www.gruppotres.it)  
 Technical drawing available on [www.gruppotres.it](http://www.gruppotres.it)

## INSTALLAZIONE / INSTALLATION

DISPONIBILE ANCHE NELLE VERSIONI: 3 - 4 - 5 - 6 - 7 - 8 (RIFERIMENTO PAG. 2)  
 AVAILABLE ALSO IN VERSIONS 3 - 4 - 5 - 6 - 7 - 8 (REF. PAGE 2)

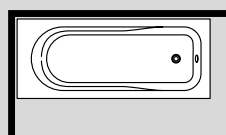

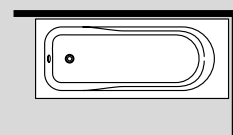

1(SX)



2(DX)

MODELLO MODEL	ARTICOLO ARTICLE	DESCRIZIONE DESCRIPTION	
<b>VASCA INCASSO - BUILT-IN BATHTUB</b>			
<b>VIN</b>	V4320 V4330 V4360 V4370	INCASSO BUILT-IN	<b>450</b>
<b>VASCA CON TELAIO - BATHTUB WITH FRAME</b>			
<b>VTL</b>	V4321 V4331 V4361 V4371	SENZA IDROMASSAGGIO WITHOUT WHIRLPOOL	<b>750</b>
<b>VASCA CON IDROMASSAGGIO - BATHTUB WITH WHIRLPOOL</b>			
<b>PRA</b>	V4322 V4332 V4362 V4372	IDROMASSAGGIO CON IMPIANTO PNEUMATICO WHIRLPOOL WITH PNEUMATIC START	<b>1.800</b>

## PANNELLI PER VASCA - PANELS FOR BATHTUB

	V432F V433F V436F V437F	PANNELLO FRONTALE FRONTAL PANEL	<b>150</b>
	V437L D/S	PANNELLO LATERALE DESTRO O SINISTRO RIGHT OR LEFT SIDE PANEL	<b>100</b>

**DOTAZIONI VASCA**  
**BATHTUB SUPPLY**

		VIN-VTL	PRA
• <b>JET IDROMASSAGGIO</b> - WHIRLPOOL JET		—	6
• <b>JET AIRPOOL</b> - AIRPOOL JET		—	—
• <b>COLONNA DI SCARICO</b> - DRAIN COLUMN		●	●
• <b>SENSORE DI LIVELLO</b> - LEVEL SENSOR		—	●
• <b>MASSIMO CONTENUTO ACQUA</b> - Max water capacity	CM 140X70	120 LT.	120 LT.
	CM 150X70	130 LT.	130 LT.
	CM 160X70	150 LT.	150 LT.
	CM 170X70	180 LT.	180 LT.

**LEGENDA - LEGEND**

- **Di serie** - Of series
- **Non disponibile** - Not available

	RUBINETTERIA E CUSCINO		CROMO
	TAPS AND PILLOW		CHROME
<b>MIX</b>	<b>MISCELATORE MONOCOMANDO CON DEVIATORE E DOCGETTA</b> SINGLE-LEVER MIXER WITH DIVERTER AND HAND-SHOWER		<b>400</b>
<b>BVP</b>	<b>BOCCA A VELA PICCOLA</b> SMALL SAIL-SHAPED		<b>200</b>
<b>COE</b>	<b>SUPPLEMENTO PER COLONNA DI SCARICO CON EROGAZIONE</b> SURCHARGE POP UP & OVERFLOW WITH WATER OUTLET SPOUT		<b>80</b>
<b>CUS</b>	<b>CUSCINO POGGIATESTA MORBIDO NERO</b> SOFT PILLOW HEADREST BLACK	<b>150</b>	
<b>FOR</b>	<b>SUPPLEMENTO PER FORATURA RUBINETTERIA DIVERSA DA QUELLE PRESENTI SUL NOSTRO LISTINO</b> SURCHARGE FOR TAPS DRILLING IF TAPS ARE NOT OUR MODELS	<b>500</b>	

# Playa 180 x 70 x 64h

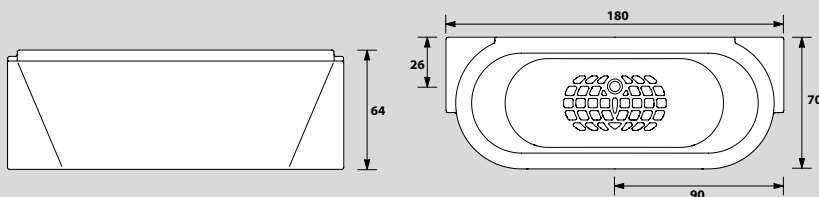

Scheda tecnica disponibile sul sito [www.gruppotes.it](http://www.gruppotes.it)  
 Technical drawing available on [www.gruppotes.it](http://www.gruppotes.it)

## INSTALLAZIONE / INSTALLATION

DISPONIBILE ANCHE NELLE VERSIONI: 5 - 6 - 7 - 8 (RIFERIMENTO PAG 2)

AVAILABLE ALSO IN VERSIONS: 5 - 6 - 7 - 8 (REF. PAGE 2)

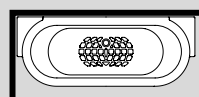

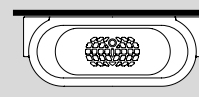

1(SX)



2(DX)

MODELLO MODEL	ARTICOLO ARTICLE	DESCRIZIONE DESCRIPTION	
<b>VASCA INCASSO - BUILT-IN BATHTUB</b>			
<b>VIN</b>	<b>V8180</b>	<b>INCASSO BUILT-IN</b>	<b>850</b>
<b>VASCA CON TELAIO - BATHTUB WITH FRAME</b>			
<b>VTL</b>	<b>V8181</b>	<b>SENZA IDROMASSAGGIO WITHOUT WHIRLPOOL</b>	<b>1.150</b>
<b>VASCA CON IDROMASSAGGIO - BATHTUB WITH WHIRLPOOL</b>			
<b>STD</b>	<b>STANDARD DIGITALE</b>	<b>V8187</b>	<b>IDROMASSAGGIO CON AVVIAMENTO DIGITALE WHIRLPOOL WITH DIGITAL START</b>
			<b>2.400</b>
<b>STX</b>	<b>STANDARD EXTRA</b>	<b>V818B</b>	<b>IDROMASSAGGIO CON IMPIANTO DIGITALE E FARO SUBACQUEO WHIRLPOOL WITH DIGITAL SYSTEM AND UNDERWATER LAMP</b>
			<b>3.000</b>

## PANNELLI PER VASCA - PANELS FOR BATHTUB

	<b>V818L D/S</b>	<b>PANNELLO LATERALE DESTRO O SINISTRO RIGHT OR LEFT SIDE PANEL</b>	<b>300</b>
	<b>V818F</b>	<b>PANNELLO FRONTALE FRONTAL PANEL</b>	<b>350</b>

DOTAZIONI VASCA BATHTUB SUPPLY	VIN-VTL	STD	STX
• JET IDROMASSAGGIO - WHIRLPOOL JET	—	6	6
• FARO SUBACQUEO - UNDERWATER LAMP	—	—	●
• COLONNA DI SCARICO - DRAIN COLUMN	●	●	●
• SENSORE DI LIVELLO - LEVEL SENSOR	—	●	●
• MASSIMO CONTENUTO ACQUA - MAX WATER CAPACITY	170 LT.	170 LT.	170 LT.

**LEGENDA - LEGEND**

- Di serie - Of series
- Non disponibile - Not available

	OPTIONAL VASCA BATHTUB OPTIONALS	STD	STX
STATA	STABILIZZATORE TEMPERATURA ACQUA - WATER TEMPERATURE STABILIZER	600	600
CROMO	CROMOTERAPIA - CHROMOTHERAPY	700	700
BORDO	KIT PROFILO BORDO VASCA - BATHTUB EDGE SKIRTING KIT	50	50
FINOR	SUPPLEMENTO PER FINITURE ORO - SURCHARGE FOR GOLDEN FINISH	300	300

	RUBINETTERIA TAPS		CROMO CHROME	ORO GOLD
MIX	MISCELATORE MONOCOMANDO CON DEVIATORE E DOCCETTA SINGLE-LEVER MIXER WITH DIVERTER AND HAND-SHOWER		400	650
MLQ	MISCELATORE MONOCOMANDO QUADRATO CON DEVIATORE E DOCCETTA SQUARED SINGLE-LEVER MIXER WITH DIVERTER AND HAND-SHOWER		500	800
LINE	RUBINETTERIA ACQUA CALDA ACQUA FREDDA CON DEVIATORE E DOCCETTA SEMI-INCASSO HOT/COLD WATER TAPS WITH DIVERTER AND SEMI-BUILT IN HAND SHOWER		1.000	—
RUE	RUBINETTERIA ELETTRONICA CON DEVIATORE E DOCCETTA SEMI-INCASSO ELECTRONIC WATER TAPS WITH DIVERTER AND SEMI-BUILT IN HAND SHOWER		1.500	—
BVP	BOCCA A VELA PICCOLA SMALL SAIL-SHAPED		200	—
BVC	BOCCA A VELA PICCOLA MODELLO CUBO SMALL SAIL-SHAPED CUBO MODEL		200	—
COE	SUPPLEMENTO PER COLONNA DI SCARICO CON EROGAZIONE SURCHARGE FOR DRAIN COLUMN WITH WATER OUTLET		80	100
SIF	SIFONE SCARICO VASCA PLASTIC SIPHON	40		
FOR	SUPPLEMENTO PER FORATURA RUBINETTERIA DIVERSA DA QUELLE PRESENTI SUL NOSTRO LISTINO SURCHARGE FOR TAPS DRILLING IF TAPS ARE NOT OUR MODELS	500		

# 34 Suri 170 170 x 75 x 57h

(WhiVe®) bianco opaco (matt white)

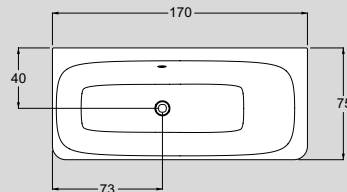
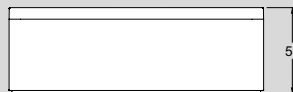

Scheda tecnica disponibile sul sito [www.gruppotes.it](http://www.gruppotes.it)  
 Technical drawing available on [www.gruppotes.it](http://www.gruppotes.it) web site

## INSTALLAZIONE / INSTALLATION

DISPONIBILE ANCHE NELLE VERSIONI: 5 - 6 (RIFERIMENTO PAG 2)

AVAILABLE ALSO IN VERSIONS: 5 - 6 (REF. PAGE 2)

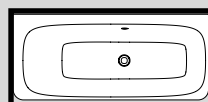

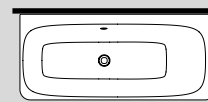

(SX)



(DX)

MODELLO MODEL	ARTICOLO ARTICLE	DESCRIZIONE DESCRIPTION		
<b>VASCA INCASSO - BUILT-IN BATHTUB</b>				
<b>VIN</b>	<b>V2770</b>	<b>INCASSO BUILT-IN</b>	<b>1.150</b>	
<b>VASCA CON TELAIO - BATHTUB WITH FRAME</b>				
<b>VTL</b>	<b>V2771</b>	<b>SENZA IDROMASSAGGIO WITHOUT WHIRLPOOL</b>	<b>1.600</b>	
<b>VASCA CON IDROMASSAGGIO - BATHTUB WITH WHIRLPOOL</b>				
<b>STD</b>	<b>STANDARD DIGITALE</b>	<b>V2777</b>	<b>IDROMASSAGGIO CON AVVIAMENTO DIGITALE WHIRLPOOL WITH DIGITAL START</b>	<b>2.900</b>
<b>STX</b>	<b>STANDARD EXTRA</b>	<b>V277B</b>	<b>IDROMASSAGGIO CON IMPIANTO DIGITALE E FARO SUBACQUEO WHIRLPOOL WITH DIGITAL CONTROL AND UNDERWATER LAMP</b>	<b>3.600</b>
<b>AWA</b>	<b>DIGITAL WHIRLPOOL AIRPOOL</b>	<b>V277N</b>	<b>IDROMASSAGGIO E AIRPOOL CON IMPIANTO DIGITALE E FARO SUBACQUEO WHIRLPOOL AND AIRPOOL WITH DIGITAL CONTROL AND UNDERWATER LAMP</b>	<b>5.100</b>

## PANNELLI PER VASCA - BATHTUB PANELS

	<b>V277F</b>	<b>PANNELLO FRONTALE FRONT PANEL</b>	<b>850</b>
	<b>V277L D/S</b>	<b>PANNELLO LATERALE SIDE PANEL</b>	<b>450</b>

<b>DOTAZIONI VASCA</b> BATHTUB SUPPLY	<b>VIN-VTL</b>	<b>STD</b>	<b>STX</b>	<b>AWA</b>
• <b>JET IDROMASSAGGIO</b> - WHIRLPOOL JET	—	6	6	6
• <b>JET AIRPOOL</b> - AIRPOOL JET	—	—	—	12
• <b>FARO SUBACQUEO</b> - UNDERWATER LAMP	—	—	●	●
• <b>COLONNA DI SCARICO</b> - DRAIN COLUMN	●	●	●	●
• <b>SENSORE DI LIVELLO</b> - LEVEL SENSOR	●	●	●	●
• <b>MASSIMO CONTENUTO ACQUA</b> - MAX WATER CAPACITY	220 LT.	220 LT.	220 LT.	220 LT.

**LEGENDA - LEGEND**

- **Di serie** - Of series
- **Non disponibile** - Not available

	<b>OPTIONAL VASCA</b> BATHTUB OPTIONALS	<b>STD</b>	<b>STX</b>	<b>AWA</b>
<b>STATA</b>	<b>STABILIZZATORE TEMPERATURA ACQUA</b> - WATER TEMPERATURE STABILIZER	600	600	600
<b>CROMO</b>	<b>CROMOTERAPIA</b> - CHROMOTHERAPY	700	700	700

	<b>RUBINETTERIA</b> TAPS		<b>CROMO</b> CHROME
<b>MIX</b>	<b>SUPPLEMENTO PER MISCELATORE MONOCOMANDO CON DEVIATORE E DOCCETTA</b> SURCHARGE FOR SINGLE-LEVER MIXER WITH DIVERTER AND HAND-SHOWER		400
<b>BVP</b>	<b>BOCCA A VELA PICCOLA</b> SMALL SAIL-SHAPED		200
<b>COE</b>	<b>SUPPLEMENTO PER COLONNA DI SCARICO CON EROGAZIONE</b> SURCHARGE FOR DRAIN COLUMN WITH WATER OUTLET		80
<b>SIF</b>	<b>SIFONE SCARICO VASCA</b> PLASTIC SIPHON	40	
<b>FOR</b>	<b>SUPPLEMENTO PER FORATURA RUBINETTERIA DIVERSA DA QUELLE PRESENTI SUL NOSTRO LISTINO</b> SURCHARGE FOR TAPS DRILLING IF TAPS ARE NOT OUR MODELS	500	



# Vasche classiche

37

## *Classic bathtubs*

<b>BLANQUE 1690</b>	38
<b>BLANQUE 1810</b>	40
<b>BLANQUE 1880</b>	42
<b>BLANQUE 1915</b>	44
<b>PERLA</b>	46

# Blanche 1690

160 x 90 x 65h

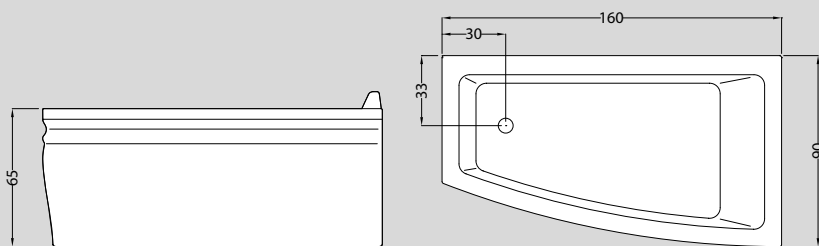

Scheda tecnica disponibile sul sito [www.gruppotes.it](http://www.gruppotes.it)  
 Technical drawing available on [www.gruppotes.it](http://www.gruppotes.it)

## INSTALLAZIONE / INSTALLATION

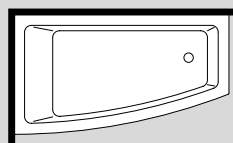

(SX)

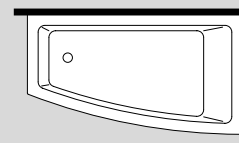

(DX)

MODELLO MODEL	ARTICOLO ARTICLE	DESCRIZIONE DESCRIPTION		
<b>VASCA INCASSO - BUILT-IN BATHTUB</b>				
<b>VIN</b>	<b>V1660</b>	<b>INCASSO BUILT-IN</b>	<b>1.350</b>	
<b>VASCA CON TELAIO - BATHTUB WITH FRAME</b>				
<b>VTL</b>	<b>V1661</b>	<b>SENZA IDROMASSAGGIO WITHOUT WHIRLPOOL</b>	<b>2.150</b>	
<b>VASCA CON IDROMASSAGGIO - BATHTUB WITH WHIRLPOOL</b>				
<b>STD</b>	<b>STANDARD DIGITAL</b>	<b>V1667</b>	<b>IDROMASSAGGIO CON AVVIAMENTO DIGITALE WHIRLPOOL WITH DIGITAL START</b>	<b>3.200</b>
<b>STX</b>	<b>STANDARD EXTRA</b>	<b>V166B</b>	<b>IDROMASSAGGIO CON IMPIANTO DIGITALE E FARO SUBACQUEO WHIRLPOOL WITH DIGITAL SYSTEM AND UNDERWATER LAMP</b>	<b>3.750</b>
<b>AWA</b>	<b>DIGITAL WHIRLPOOL AIRPOOL</b>	<b>V166N</b>	<b>IDROMASSAGGIO E AIRPOOL CON IMPIANTO DIGITALE E FARO SUBACQUEO WHIRLPOOL AND AIRPOOL WITH DIGITAL SYSTEM AND UNDERWATER LAMP</b>	<b>5.900</b>

## PANNELLI PER VASCA - PANELS FOR BATHTUB

	<b>V166F</b>	<b>PANNELLO FRONTALE FRONTAL PANEL</b>	<b>550</b>
---	--------------	--	------------

<b>DOTAZIONI VASCA BATHTUB SUPPLY</b>	<b>VIN-VTL</b>	<b>STD</b>	<b>STX</b>	<b>AWA</b>
• <b>JET IDROMASSAGGIO - WHIRLPOOL JET</b>	—	6	6	6
• <b>JET AIRPOOL - AIRPOOL JET</b>	—	—	—	12
• <b>CUSCINO POGGIATESTA MARRONE * - BROWN * HEADREST</b>	1	1	1	1
• <b>FARO SUBACQUEO - UNDERWATER LAMP</b>	—	—	●	●
• <b>MANIGLIA - HANDLE</b>	1	1	1	1
• <b>COLONNA DI SCARICO - DRAIN COLUMN</b>	●	●	●	●
• <b>SENSORE DI LIVELLO - LEVEL SENSOR</b>	—	●	●	●
• <b>SIFONE SCARICO VASCA - PLASTIC SIPHON</b>	●	●	●	●
• <b>MASSIMO CONTENUTO ACQUA - MAX WATER CAPACITY</b>	195 LT.	195 LT.	195 LT.	195 LT.

\* Disponibile su richiesta anche bianco, oro e nero / Available on request also in white, gold and black

#### LEGENDA - LEGEND

- Di serie - Of series
- Non disponibile - Not available

	<b>OPTIONAL VASCA BATHTUB OPTIONALS</b>	<b>STD</b>	<b>STX</b>	<b>AWA</b>
<b>STATA</b>	<b>STABILIZZATORE TEMPERATURA ACQUA - WATER TEMPERATURE STABILIZER</b>	<b>600</b>	<b>600</b>	<b>600</b>
<b>CROMO</b>	<b>CROMOTERAPIA - CHROMOTHERAPY</b>	<b>700</b>	<b>700</b>	<b>700</b>
<b>BORDO</b>	<b>KIT PROFILO BORDO VASCA - BATHTUB EDGE SKIRTING KIT</b>	<b>50</b>	<b>50</b>	<b>50</b>
<b>FINOR</b>	<b>SUPPLEMENTO PER FINITURE ORO - SURCHARGE FOR GOLDEN FINISH</b>	<b>300</b>	<b>300</b>	<b>300</b>

# Blanche 1810

180 x 100 x 65h

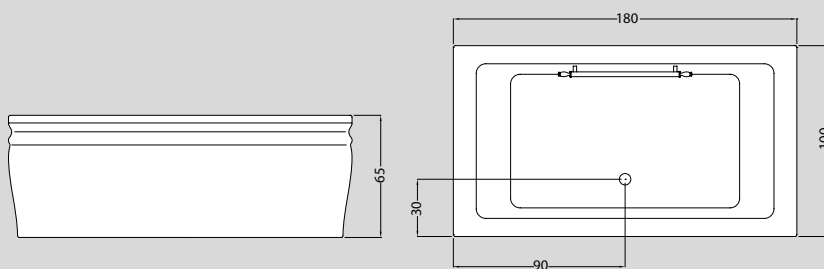

Scheda tecnica disponibile sul sito [www.gruppotes.it](http://www.gruppotes.it)  
 Technical drawing available on [www.gruppotes.it](http://www.gruppotes.it)

## INSTALLAZIONE / INSTALLATION

DISPONIBILE ANCHE NELLE VERSIONI: 5 - 6 - 7 - 8 (RIFERIMENTO PAG 2)

AVAILABLE ALSO IN VERSIONS: 5 - 6 - 7 - 8 (REF. PAGE 2)

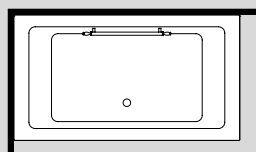

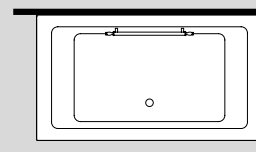

1(SX)



2(DX)

MODELLO MODEL	ARTICOLO ARTICLE	DESCRIZIONE DESCRIPTION		
<b>VASCA INCASSO - BUILT-IN BATHTUB</b>				
<b>VIN</b>	<b>V1610</b>	<b>INCASSO BUILT-IN</b>	<b>1.600</b>	
<b>VASCA CON TELAIO - BATHTUB WITH FRAME</b>				
<b>VTL</b>	<b>V1611</b>	<b>SENZA IDROMASSAGGIO WITHOUT WHIRLPOOL</b>	<b>1.900</b>	
<b>VASCA CON IDROMASSAGGIO - BATHTUB WITH WHIRLPOOL</b>				
<b>STD</b>	<b>STANDARD DIGITAL</b>	<b>V1617</b>	<b>IDROMASSAGGIO CON AVVIAMENTO DIGITALE WHIRLPOOL WITH DIGITAL START</b>	<b>3.300</b>
<b>STX</b>	<b>STANDARD EXTRA</b>	<b>V161B</b>	<b>IDROMASSAGGIO CON IMPIANTO DIGITALE E FARO SUBACQUEO WHIRLPOOL WITH DIGITAL SYSTEM AND UNDERWATER LAMP</b>	<b>3.800</b>
<b>AWA</b>	<b>DIGITAL WHIRLPOOL AIRPOOL</b>	<b>V161N</b>	<b>IDROMASSAGGIO E AIRPOOL CON IMPIANTO DIGITALE E FARO SUBACQUEO WHIRLPOOL AND AIRPOOL WITH DIGITAL SYSTEM AND UNDERWATER LAMP</b>	<b>5.500</b>

## PANNELLI PER VASCA - PANELS FOR BATHTUB

	<b>V161F</b>	<b>PANNELLO FRONTALE FRONTAL PANEL</b>	<b>450</b>
	<b>V161L D/S</b>	<b>PANNELLO LATERALE DESTRO O SINISTRO RIGHT OR LEFT SIDE PANEL</b>	<b>350</b>

DOTAZIONI VASCA BATHTUB SUPPLY	VIN-VTL	STD	STX	AWA
• JET IDROMASSAGGIO - WHIRLPOOL JET	—	6	6	6
• JET AIRPOOL - AIRPOOL JET	—	—	—	18
• CUSCINO POGGIATESTA MARRONE * - BROWN * HEADREST	1	1	1	1
• FARO SUBACQUEO - UNDERWATER LAMP	—	—	●	●
• MANIGLIA - HANDLE	1	1	1	1
• COLONNA DI SCARICO - DRAIN COLUMN	●	●	●	●
• SENSORE DI LIVELLO - LEVEL SENSOR	—	●	●	●
• SIFONE SCARICO VASCA - PLASTIC SIPHON	●	●	●	●
• MASSIMO CONTENUTO ACQUA - MAX WATER CAPACITY	240 LT.	240 LT.	240 LT.	240 LT.

\* Disponibile su richiesta anche bianco, oro e nero / Available on request also in white, gold and black

#### LEGENDA - LEGEND

- Di serie - Of series
- Non disponibile - Not available

	OPTIONAL VASCA BATHTUB OPTIONALS	STD	STX	AWA
STATA	STABILIZZATORE TEMPERATURA ACQUA - WATER TEMPERATURE STABILIZER	600	600	600
CROMO	CROMOTERAPIA - CHROMOTHERAPY	700	700	700
BORDO	KIT PROFILO BORDO VASCA - BATHTUB EDGE SKIRTING KIT	50	50	50
168Q	CUSCINO POGGIATESTA AGGIUNTIVO MORBIDO (MARRONE*) - ADDITIONAL SOFT PILLOW HEADREST (BROWN*)	150	150	150
FINOR	SUPPLEMENTO PER FINITURE ORO - SURCHARGE FOR GOLDEN FINISH	300	300	300

\* Disponibile su richiesta anche bianco, oro e nero / Available on request also in white, gold and black

# Blanche 1880

180 x 80 x 65h

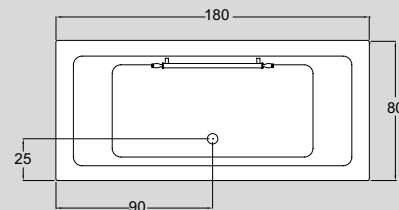
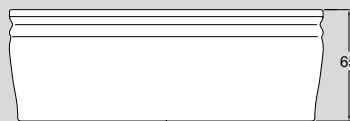

Scheda tecnica disponibile sul sito [www.gruppotes.it](http://www.gruppotes.it)  
 Technical drawing available on [www.gruppotes.it](http://www.gruppotes.it)

## INSTALLAZIONE / INSTALLATION

DISPONIBILE ANCHE NELLE VERSIONI: 5 - 6 - 7 - 8 (RIFERIMENTO PAG 2)

AVAILABLE ALSO IN VERSIONS: 5 - 6 - 7 - 8 (REF. PAGE 2)

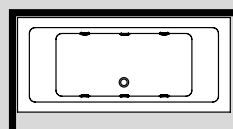

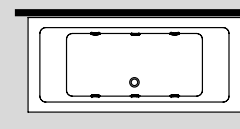

1(SX)



2(DX)

MODELLO MODEL	ARTICOLO ARTICLE	DESCRIZIONE DESCRIPTION		
<b>VASCA INCASSO - BUILT-IN BATHTUB</b>				
<b>VIN</b>	<b>V1680</b>	<b>INCASSO BUILT-IN</b>	<b>1.250</b>	
<b>VASCA CON TELAIO - BATHTUB WITH FRAME</b>				
<b>VTL</b>	<b>V1681</b>	<b>SENZA IDROMASSAGGIO WITHOUT WHIRLPOOL</b>	<b>1.450</b>	
<b>VASCA CON IDROMASSAGGIO - BATHTUB WITH WHIRLPOOL</b>				
<b>STD</b>	<b>STANDARD DIGITAL</b>	<b>V1687</b>	<b>IDROMASSAGGIO CON AVVIAMENTO DIGITALE WHIRLPOOL WITH DIGITAL START</b>	<b>3.000</b>
<b>STX</b>	<b>STANDARD EXTRA</b>	<b>V168B</b>	<b>IDROMASSAGGIO CON IMPIANTO DIGITALE E FARO SUBACQUEO WHIRLPOOL WITH DIGITAL SYSTEM AND UNDERWATER LAMP</b>	<b>3.500</b>
<b>AWA</b>	<b>DIGITAL WHIRLPOOL AIRPOOL</b>	<b>V168N</b>	<b>IDROMASSAGGIO E AIRPOOL CON IMPIANTO DIGITALE E FARO SUBACQUEO WHIRLPOOL AND AIRPOOL WITH DIGITAL SYSTEM AND UNDERWATER LAMP</b>	<b>5.100</b>

## PANNELLI PER VASCA - PANELS FOR BATHTUB

	<b>V168F</b>	<b>PANNELLO FRONTALE FRONTAL PANEL</b>	<b>450</b>
	<b>V168 D/S</b>	<b>PANNELLO LATERALE DESTRO O SINISTRO RIGHT OR LEFT SIDE PANEL</b>	<b>350</b>

DOTAZIONI VASCA BATHTUB SUPPLY	VIN-VTL	STD	STX	AWA
• JET IDROMASSAGGIO - WHIRLPOOL JET	—	6	6	6
• JET AIRPOOL - AIRPOOL JET	—	—	—	12
• CUSCINO POGGIATESTA MARRONE * - BROWN * HEADREST	1	1	1	1
• FARO SUBACQUEO - UNDERWATER LAMP	—	—	●	●
• MANIGLIA - HANDLE	1	1	1	1
• COLONNA DI SCARICO - DRAIN COLUMN	●	●	●	●
• SENSORE DI LIVELLO - LEVEL SENSOR	—	●	●	●
• SIFONE SCARICO VASCA - PLASTIC SIPHON	●	●	●	●
• MASSIMO CONTENUTO ACQUA - MAX WATER CAPACITY	200 LT.	200 LT.	200 LT.	200 LT.

\* Disponibile su richiesta anche bianco, oro e nero / Available on request also in white, gold and black

#### LEGENDA - LEGEND

- Di serie - Of series
- Non disponibile - Not available

	OPTIONAL VASCA BATHTUB OPTIONALS	STD	STX	AWA
STATA	STABILIZZATORE TEMPERATURA ACQUA - WATER TEMPERATURE STABILIZER	600	600	600
CROMO	CROMOTERAPIA - CHROMOTHERAPY	700	700	700
BORDO	KIT PROFILO BORDO VASCA - BATHTUB EDGE SKIRTING KIT	50	50	50
168Q	CUSCINO POGGIATESTA AGGIUNTIVO MORBIDO (MARRONE*) - ADDITIONAL SOFT PILLOW HEADREST (BROWN*)	150	150	150
FINOR	SUPPLEMENTO PER FINITURE ORO - SURCHARGE FOR GOLDEN FINISH	300	300	300

\* Disponibile su richiesta anche bianco, oro e nero / Available on request also in white, gold and black

# Blanche 1915

190 x 150 x 68h

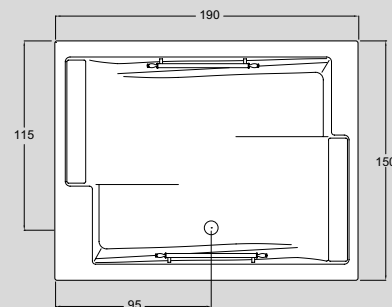
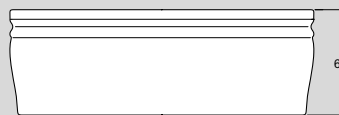

Scheda tecnica disponibile sul sito [www.gruppotes.it](http://www.gruppotes.it)  
 Technical drawing available on [www.gruppotes.it](http://www.gruppotes.it)

## INSTALLAZIONE / INSTALLATION

DISPONIBILE ANCHE NELLE VERSIONI: 5 - 6 - 7 - 8 (RIFERIMENTO PAG 2)  
 AVAILABLE ALSO IN VERSIONS: 5 - 6 - 7 - 8 (REF. PAGE 2)

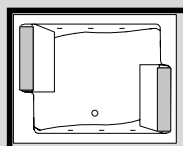

1(SX)

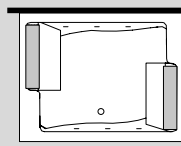

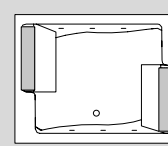

2(DX)

CENTRO STANZA  
FREESTANDING

MODELLO MODEL	ARTICOLO ARTICLE	DESCRIZIONE DESCRIPTION		
<b>VASCA CON TELAIO - BATHTUB WITH FRAME</b>				
<b>VTL</b>	<b>V1691</b>	<b>SENZA IDROMASSAGGIO WITHOUT WHIRLPOOL</b>	<b>3.200</b>	
<b>VASCA CON IDROMASSAGGIO - BATHTUB WITH WHIRLPOOL</b>				
<b>STD</b>	<b>STANDARD DIGITAL</b>	<b>V1697</b>	<b>IDROMASSAGGIO CON AVVIAMENTO DIGITALE WHIRLPOOL WITH DIGITAL START</b>	<b>5.800</b>
<b>STX</b>	<b>STANDARD EXTRA</b>	<b>V169B</b>	<b>IDROMASSAGGIO CON IMPIANTO DIGITALE E FARO SUBACQUEO WHIRLPOOL WITH DIGITAL SYSTEM AND UNDERWATER LAMP</b>	<b>6.450</b>
<b>AWA</b>	<b>DIGITAL WHIRLPOOL AIRPOOL</b>	<b>V169N</b>	<b>IDROMASSAGGIO E AIRPOOL CON IMPIANTO DIGITALE E FARO SUBACQUEO WHIRLPOOL AND AIRPOOL WITH DIGITAL SYSTEM AND UNDERWATER LAMP</b>	<b>8.100</b>

## PANNELLI PER VASCA - PANELS FOR BATHTUB

	<b>V169F</b>	<b>PANNELLO FRONTALE FRONTAL PANEL</b>	<b>550</b>
	<b>V169L D/S</b>	<b>PANNELLO LATERALE DESTRO O SINISTRO RIGHT OR LEFT SIDE PANEL</b>	<b>450</b>

<b>DOTAZIONI VASCA BATHTUB SUPPLY</b>	<b>VTL</b>	<b>STD</b>	<b>STX</b>	<b>AWA</b>
• <b>JET IDROMASSAGGIO - WHIRLPOOL JET</b>	—	8	8	8
• <b>JET AIRPOOL - AIRPOOL JET</b>	—	—	—	24
• <b>CUSCINO POGGIATESTA MARRONE * - BROWN * HEADREST</b>	2	2	2	2
• <b>FARO SUBACQUEO - UNDERWATER LAMP</b>	—	—	●	●
• <b>MANIGLIA - HANDLE</b>	2	2	2	2
• <b>COLONNA DI SCARICO - DRAIN COLUMN</b>	●	●	●	●
• <b>SENSORE DI LIVELLO - LEVEL SENSOR</b>	—	●	●	●
• <b>SIFONE SCARICO VASCA - PLASTIC SIPHON</b>	●	●	●	●
• <b>MASSIMO CONTENUTO ACQUA - MAX WATER CAPACITY</b>	480 LT.	480 LT.	480 LT.	480 LT.

\* **Disponibile su richiesta anche bianco, oro e nero** / Available on request also in white, gold and black

**LEGENDA - LEGEND**

- **Di serie - Of series**
- **Non disponibile - Not available**

	<b>OPTIONAL VASCA BATHTUB OPTIONALS</b>	<b>STD</b>	<b>STX</b>	<b>AWA</b>
<b>STATA</b>	<b>STABILIZZATORE TEMPERATURA ACQUA - WATER TEMPERATURE STABILIZER</b>	<b>600</b>	<b>600</b>	<b>600</b>
<b>CROMO</b>	<b>CROMOTERAPIA - CHROMOTHERAPY</b>	<b>700</b>	<b>700</b>	<b>700</b>
<b>BORDO</b>	<b>KIT PROFILO BORDO VASCA - BATHTUB EDGE SKIRTING KIT</b>	<b>50</b>	<b>50</b>	<b>50</b>
<b>SOL</b>	<b>SOLLEVATORE PNEUMATICO PER VASCA INCASSO - PNEUMATICLIFT FOR BUILT-IN BATHTUB</b>	<b>4.500</b>	<b>4.500</b>	<b>4.500</b>
<b>FINOR</b>	<b>SUPPLEMENTO PER FINITURE ORO - SURCHARGE FOR GOLDEN FINISH</b>	<b>450</b>	<b>450</b>	<b>450</b>

# Perla $\varnothing 182 \times 65h$

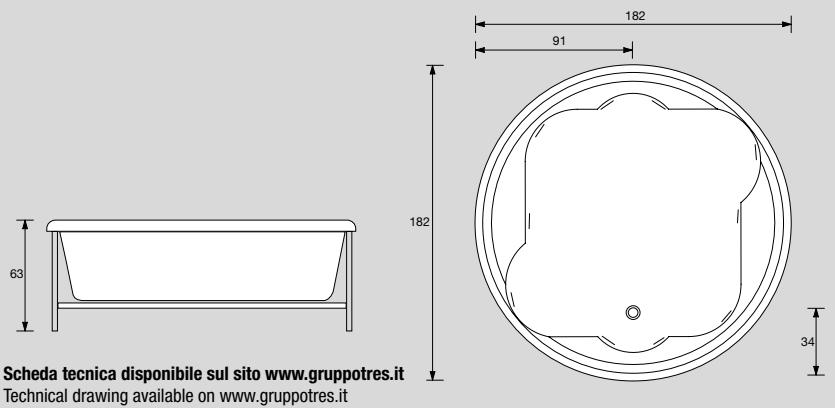

## INSTALLAZIONE / INSTALLATION

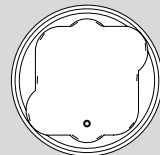

**CENTRO STANZA**  
FREESTANDING

MODELLO MODEL	ARTICOLO ARTICLE	DESCRIZIONE DESCRIPTION	
<b>VASCA CON TELAIO - BATHTUB WITH FRAME</b>			
<b>VTL</b>	<b>V6691</b>	<b>SENZA IDROMASSAGGIO</b> WITHOUT WHIRLPOOL	<b>2.800</b>
<b>VASCA CON IDROMASSAGGIO - BATHTUB WITH WHIRLPOOL</b>			
<b>STD</b>	<b>V6697</b>	<b>IDROMASSAGGIO CON AVVIAMENTO DIGITALE</b> WHIRLPOOL WITH DIGITAL START	<b>5.800</b>
<b>STX</b>	<b>V669B</b>	<b>IDROMASSAGGIO CON IMPIANTO DIGITALE E FARO SUBACQUEO</b> WHIRLPOOL WITH DIGITAL SYSTEM AND UNDERWATER LAMP	<b>6.450</b>
<b>AWA</b>	<b>V669N</b>	<b>IDROMASSAGGIO E AIRPOOL CON IMPIANTO DIGITALE E FARO SUBACQUEO</b> WHIRLPOOL AND AIRPOOL WITH DIGITAL SYSTEM AND UNDERWATER LAMP	<b>8.100</b>

DOTAZIONI VASCA BATHTUB SUPPLY	VTL	STD	STX	AWA
• JET IDROMASSAGGIO - WHIRLPOOL JET	—	8	8	8
• JET AIRPOOL - AIRPOOL JET	—	—	—	24
• FARO SUBACQUEO - UNDERWATER LAMP	—	—	●	●
• COLONNA DI SCARICO - DRAIN COLUMN	●	●	●	●
• MANIGLIA - HANDLE	2	2	2	2
• SENSORE DI LIVELLO - LEVEL SENSOR	—	●	●	●
• MASSIMO CONTENUTO ACQUA - MAX WATER CAPACITY	400 LT.	400 LT.	400 LT.	400 LT.

**LEGENDA - LEGEND**

- Di serie - Of series
- Non disponibile - Not available

	OPTIONAL VASCA BATHTUB OPTIONALS	STD	STX	AWA
STATA	STABILIZZATORE TEMPERATURA ACQUA - WATER TEMPERATURE STABILIZER	600	600	600
CROMO	CROMOTERAPIA - CHROMOTHERAPY	700	700	700
BORDO	KIT PROFILO BORDO VASCA - BATHTUB EDGE SKIRTING KIT	50	50	50
SOL	SOLLEVATORE PNEUMATICO PER VASCA INCASSO - PNEUMATICLIFT FOR BUILT-IN BATHTUB	4.500	4.500	4.500
FINOR	SUPPLEMENTO PER FINITURE ORO - SURCHARGE FOR GOLDEN FINISH	300	300	300

	RUBINETTERIA TAPS		CROMO CHROME	ORO GOLD
MIX	MISCELATORE MONOCOMANDO CON DEVIATORE E DOCCETTA SINGLE-LEVER MIXER WITH DIVERTER AND HAND-SHOWER		400	650
MLQ	MISCELATORE MONOCOMANDO QUADRATO CON DEVIATORE E DOCCETTA SQUARED SINGLE-LEVER MIXER WITH DIVERTER AND HAND-SHOWER		500	800
LINE	RUBINETTERIA ACQUA CALDA ACQUA FREDDA CON DEVIATORE E DOCCETTA SEMI-INCASSO HOT/COLD WATER TAPS WITH DIVERTER AND SEMI-BUILT IN HAND SHOWER		1.000	—
RUE	RUBINETTERIA ELETTRONICA CON DEVIATORE E DOCCETTA SEMI-INCASSO ELECTRONIC WATER TAPS WITH DIVERTER AND SEMI-BUILT IN HAND SHOWER		1.500	—
SIF	SIFONE SCARICO VASCA PLASTIC SIPHON	40		
BVP	BOCCA A VELA PICCOLA SMALL SAIL-SHAPED		200	—
COE	SUPPLEMENTO PER COLONNA DI SCARICO CON EROGAZIONE SURCHARGE POP UP & OVERFLOW WITH WATER OUTLET SPOUT		80	100
FOR	SUPPLEMENTO PER FORATURA RUBINETTERIA DIVERSA DA QUELLE PRESENTI SUL NOSTRO LISTINO SURCHARGE FOR TAPS DRILLING IF TAPS ARE NOT OUR MODELS	500		

# Linea special

## *Special line*

<b>GEN-D</b>	49
<b>GEN-X</b>	50
<b>GEN-X TOP</b>	52
<b>GEN-Y</b>	54
<b>GEN-Y TOP</b>	56

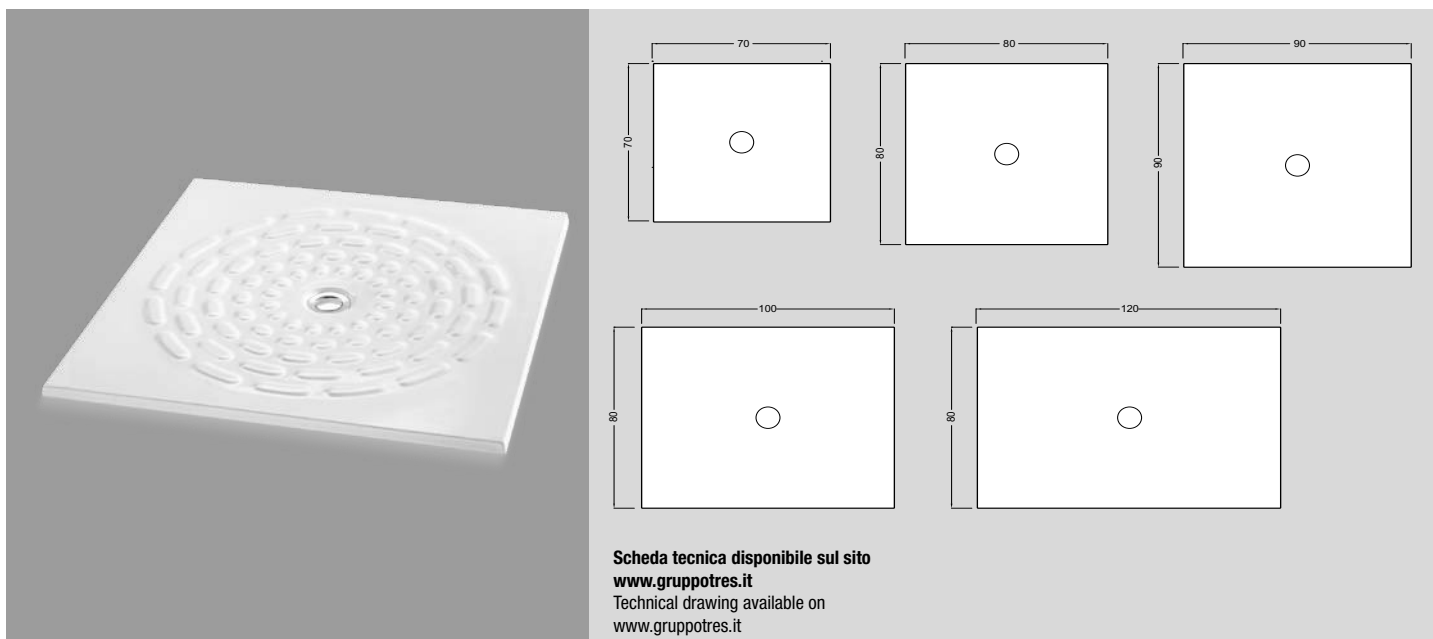

MODELLO MODEL	ARTICOLO ARTICLE	DESCRIZIONE DESCRIPTION	
<b>PIATTO DOCCIA 70X70 - SHOWER TRAY 70X70</b>			
	<b>PD70FP</b>	<b>PIATTO DOCCIA FILO PAVIMENTO</b> FLUSH TO THE FLOOR SHOWER TRAY	<b>250</b>
<b>PIATTO DOCCIA 80X80 - SHOWER TRAY 80X80</b>			
	<b>PD80FP</b>	<b>PIATTO DOCCIA FILO PAVIMENTO</b> FLUSH TO THE FLOOR SHOWER TRAY	<b>250</b>
<b>PIATTO DOCCIA 90X90 - SHOWER TRAY 90X90</b>			
	<b>PD90FP</b>	<b>PIATTO DOCCIA FILO PAVIMENTO</b> FLUSH TO THE FLOOR SHOWER TRAY	<b>300</b>
<b>PIATTO DOCCIA 80X100 - SHOWER TRAY 80X100</b>			
	<b>PD810FP</b>	<b>PIATTO DOCCIA FILO PAVIMENTO</b> FLUSH TO THE FLOOR SHOWER TRAY	<b>350</b>
<b>PIATTO DOCCIA 80X120 - SHOWER TRAY 80X120</b>			
	<b>PD812FP</b>	<b>PIATTO DOCCIA FILO PAVIMENTO</b> FLUSH TO THE FLOOR SHOWER TRAY	<b>350</b>

	OPTIONAL OPTIONALS	CROMO CHROME
<b>3RB.PIL.XCX.S/FORO</b>	<b>PILETTA DI SCARICO - DRAIN PIPE</b>	<b>40</b>

# Gen-X 130 x 75 x 105h

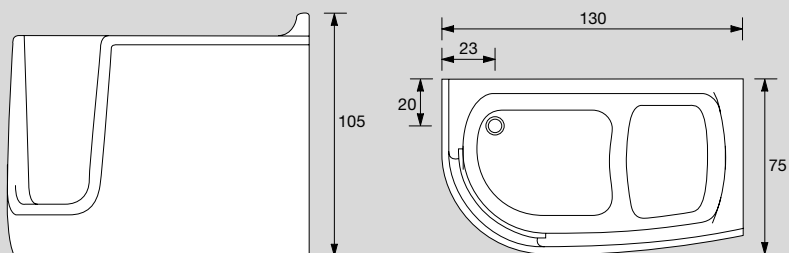

Scheda tecnica disponibile sul sito [www.gruppotes.it](http://www.gruppotes.it)  
 Technical drawing available on [www.gruppotes.it](http://www.gruppotes.it)

## INSTALLAZIONE / INSTALLATION

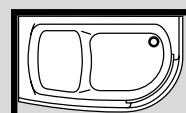

1(SX)

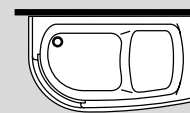

2(DX)

MODELLO MODEL	ARTICOLO ARTICLE	DESCRIZIONE DESCRIPTION	
<b>VASCA CON TELAIO + PANNELLO - BATHTUB WITH CHASSIS + PANEL</b>			
<b>VTL</b>	<b>V3311</b>	<b>SENZA IDROMASSAGGIO WITHOUT WHIRLPOOL</b>	<b>5.000</b>
<b>VASCA CON IDROMASSAGGIO + PANNELLO - BATHTUB WITH WHIRLPOOL + PANEL</b>			
<b>STD</b>	<b>STANDARD DIGITALE</b>	<b>V3317</b> <b>IDROMASSAGGIO CON AVVIAMENTO DIGITALE WHIRLPOOL WITH DIGITAL START</b>	<b>6.200</b>

DOTAZIONI VASCA BATHTUB SUPPLY		VTL	STD
• JET IDROMASSAGGIO - WHIRLPOOL JET		—	8
• COLONNA DI SCARICO CON EROGAZIONE - DRAIN COLUMN WITH WATER OUTLET		●	●
• MISCELATORE MONOCOMANDO CON DEVIATORE E DOCCETTA - SINGLE-LEVER MIXER WITH DIVERTER AND SHOWER-HEAD		●	●
• SENSORE DI LIVELLO - LEVEL SENSOR		—	●
• PANNELLO FRONTALE - FRONTAL PANEL		●	●
• MASSIMO CONTENUTO ACQUA - MAX WATER CAPACITY		270 LT.	270 LT.

**LEGENDA - LEGEND**

- Di serie - Of series
- Non disponibile - Not available

OPTIONAL VASCA BATHTUB OPTIONALS		VTL	STD
STATA	STABILIZZATORE TEMPERATURA ACQUA - WATER TEMPERATURE STABILIZER	—	600
*SVUO	SVUOTAMENTO RAPIDO - RAPID EMPTYING	650	650
CROMO	CROMOTERAPIA - CHROMOTHERAPY	—	700
BORDOM	KIT PROFILO BORDO VASCA MORBIDO - BATHTUB SOFT EDGE SKIRTING KIT	50	50

\*ATTENZIONE: LO SVUOTAMENTO RAPIDO SI PUÒ INSERIRE SOLO SE LO SCARICO DELLA VASCA È DIRETTO, SENZA PASSARE PER SCATOLE SIFONATE.  
ATTENTION: THE RAPID EMPTYING CAN BE POSSIBLE ONLY IF THE DISCHARGE IS DIRECTED, WITHOUT TO PASS FOR SIPHON BOXES.

RUBINETTERIA TAPS			CROMO CHROME
RUE	SUPPLEMENTO RUBINETTERIA ELETTRONICA CON DEVIATORE E DOCCETTA SEMI-INCASSO SURCHARGE ELECTRONIC WATER TAPS WITH DIVERTER AND SEMI-BUILT IN HAND SHOWER		1.100
SIF	SIFONE SCARICO VASCA PLASTIC SIPHON	40	

# Gen-x Top 130 x 75 x 220h

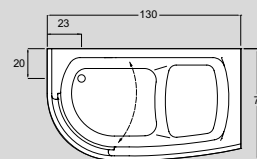
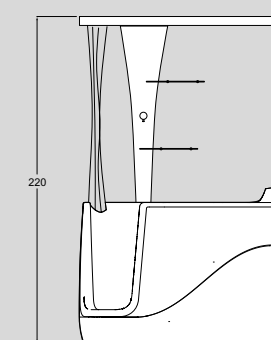

Scheda tecnica disponibile sul sito [www.gruppotres.it](http://www.gruppotres.it)  
 Technical drawing available on [www.gruppotres.it](http://www.gruppotres.it)

## INSTALLAZIONE / INSTALLATION

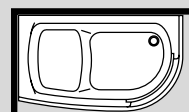

1(SX)

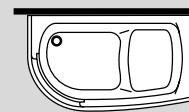

2(DX)

MODELLO MODEL	ARTICOLO ARTICLE	DESCRIZIONE DESCRIPTION	
<b>VASCA CON TELAIO+PANNELLO+SISTEMA DOCCIA - BATHTUB WITH CHASSIS+PANEL+SHOWER SYSTEM</b>			
<b>VTL</b>	<b>V3311</b> (VASCA) <b>B3311</b> (BOX)	<b>SENZA IDROMASSAGGIO + SISTEMA DOCCIA</b> WITHOUT WHIRLPOOL + SHOWER SYSTEM	<b>6.600</b>
<b>VASCA CON IDROMASSAGGIO+PANNELLO+SISTEMA DOCCIA - BATHTUB WITH WHIRLPOOL + PANEL+SHOWER SYSTEM</b>			
<b>STD</b>	<b>STANDARD DIGITALE</b> <b>V3317</b> (VASCA) <b>B3311</b> (BOX)	<b>IDROMASSAGGIO CON AVVIAMENTO DIGITALE + SISTEMA DOCCIA</b> WHIRLPOOL WITH DIGITAL START + SHOWER SYSTEM	<b>7.800</b>

DOTAZIONI VASCA BATHTUB SUPPLY	VTL	STD
• JET IDROMASSAGGIO - WHIRLPOOL JET	—	8
• COLONNA DI SCARICO CON EROGAZIONE - DRAIN COLUMN WITH WATER OUTLET	●	●
• MISCELATORE MONOCOMANDO CON DEVIATORE E DOCCETTA - SINGLE-LEVER MIXER WITH DIVERTER AND SHOWER-HEAD	●	●
• SENSORE DI LIVELLO - LEVEL SENSOR	—	●
• PANNELLO FRONTALE - FRONTAL PANEL	●	●
• MASSIMO CONTENUTO ACQUA - MAX WATER CAPACITY	270 LT.	270 LT.

LEGENDA - LEGEND ● Di serie - Of series — Non disponibile - Not available

DOTAZIONI DOCCIA SHOWER SUPPLY	
• SCORREVOLE IN ACCIAIO E TENDA DOCCIA IN TESSUTO CON ANELLI / STAINLESS STEEL RAIL WITH WATERPROOF FABRIC CURTAIN WITH RINGS	●
• MISCELATORE MONOCOMANDO CON DEVIATORE / SINGLE-LEVER MIXER WITH DIVERTER	●
• TETTO CON DOCCIONE / MULTI-FUNCTION SHOWER CEILING WITH SHOWER HEAD	●
• N° 2 MENSOLE PORTAOGGETTI / N° 2 GLASS SHELVES	●

	OPTIONAL VASCA BATHTUB OPTIONALS	VTL	STD
STATA	STABILIZZATORE TEMPERATURA ACQUA - WATER TEMPERATURE STABILIZER	—	600
*SVUO	SVUOTAMENTO RAPIDO - RAPID EMPTYING	650	650
CROMO	CROMOTERAPIA - CHROMOTHERAPY	—	700
BORDOM	KIT PROFILO BORDO VASCA MORBIDO - BATHTUB SOFT EDGE SKIRTING KIT	50	50

\*ATTENZIONE: LO SVUOTAMENTO RAPIDO SI PUÒ INSERIRE SOLO SE LO SCARICO DELLA VASCA È DIRETTO, SENZA PASSARE PER SCATOLE SIFONATE.  
ATTENTION: THE RAPID EMPTYING CAN BE POSSIBLE ONLY IF THE DISCHARGE IS DIRECTED, WITHOUT TO PASS FOR SIPHON BOXES.

	OPTIONAL DOCCIA SHOWER OPTIONALS	CROMO CHROME
DOCCI	DOCCIONE AGGIUNTIVO - ADDITIONAL BLOW - PIPE	350

	RUBINETTERIA TAPS	CROMO CHROME
RUE	SUPPLEMENTO RUBINETTERIA ELETTRONICA CON DEVIATORE E DOCCETTA SEMI-INCASSO SURCHARGE ELECTRONIC WATER TAPS WITH DIVERTER AND SEMI-BUILT IN HAND SHOWER	1.100
SIF	SIFONE SCARICO VASCA PLASTIC SIPHON	40

# Gen-y 120 x 70 x 90h

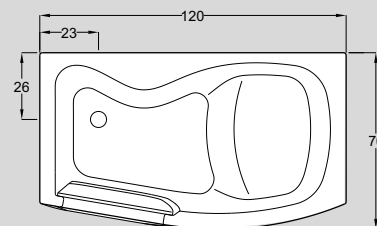
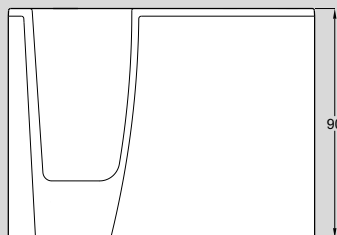

Scheda tecnica disponibile sul sito [www.gruppotres.it](http://www.gruppotres.it)  
 Technical drawing available on [www.gruppotres.it](http://www.gruppotres.it)

## INSTALLAZIONE / INSTALLATION

DISPONIBILE ANCHE NELLE VERSIONI: 5 - 6 - 7 - 8 (RIFERIMENTO PAG 2)

AVAILABLE ALSO IN VERSIONS: 5 - 6 - 7 - 8 (REF. PAGE 2)

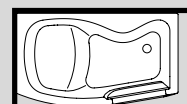

1(SX)

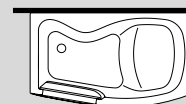

2(DX)

MODELLO MODEL	ARTICOLO ARTICLE	DESCRIZIONE DESCRIPTION	
<b>VASCA CON TELAIO + PANNELLO - BATHTUB WITH CHASSIS + PANEL</b>			
<b>VTL</b>	<b>V3411</b>	<b>SENZA IDROMASSAGGIO WITHOUT WHIRLPOOL</b>	<b>4.400</b>
<b>VASCA CON IDROMASSAGGIO + PANNELLO - BATHTUB WITH WHIRLPOOL + PANEL</b>			
<b>STD</b>	<b>STANDARD DIGITALE</b>	<b>V3417</b> <b>IDROMASSAGGIO CON AVVIAMENTO DIGITALE WHIRLPOOL WITH DIGITAL START</b>	<b>5.400</b>

## PANNELLI PER VASCA - PANELS FOR BATHTUB

	<b>V341 D/S</b>	<b>PANNELLO LATERALE DESTRO O SINISTRO RIGHT OR LEFT SIDE PANEL</b>	<b>300</b>
--	-----------------	---	------------

**DOTAZIONI VASCA**  
**BATHTUB SUPPLY**

	VTL	STD
• <b>JET IDROMASSAGGIO - WHIRLPOOL JET</b>	—	8
• <b>COLONNA DI SCARICO CON EROGAZIONE - DRAIN COLUMN WITH WATER OUTLET</b>	●	●
• <b>MISCELATORE MONOCOMANDO CON DEVIATORE E DOCCETTA - SINGLE-LEVER MIXER WITH DIVERTER AND SHOWER-HEAD</b>	●	●
• <b>SENSORE DI LIVELLO - LEVEL SENSOR</b>	—	●
• <b>PANNELLO FRONTALE - FRONTAL PANEL</b>	●	●
• <b>MASSIMO CONTENUTO ACQUA - MAX WATER CAPACITY</b>	270 LT.	270 LT.

**LEGENDA - LEGEND**

- **Di serie - Of series**  
 — **Non disponibile - Not available**

	OPTIONAL VASCA BATHTUB OPTIONALS	VTL	STD
<b>STATA</b>	<b>STABILIZZATORE TEMPERATURA ACQUA - WATER TEMPERATURE STABILIZER</b>	—	600
<b>*SVUO</b>	<b>SVUOTAMENTO RAPIDO - RAPID EMPTYING</b>	650	650
<b>CROMO</b>	<b>CROMOTERAPIA - CHROMOTHERAPY</b>	—	700
<b>BORDO</b>	<b>KIT PROFILO BORDO VASCA - BATHTUB EDGE SKIRTING KIT</b>	50	50

\*ATTENZIONE: LO SVUOTAMENTO RAPIDO SI PUÒ INSERIRE SOLO SE LO SCARICO DELLA VASCA È DIRETTO, SENZA PASSARE PER SCATOLE SIFONATE.  
 ATTENTION: THE RAPID EMPTYING CAN BE POSSIBLE ONLY IF THE DISCHARGE IS DIRECTED, WITHOUT TO PASS FOR SIPHON BOXES.

	RUBINETTERIA TAPS		CROMO CHROME
<b>RUE</b>	<b>SUPPLEMENTO RUBINETTERIA ELETTRONICA CON DEVIATORE E DOCCETTA SEMI-INCASSO</b> SURCHARGE ELECTRONIC WATER TAPS WITH DIVERTER AND SEMI-BUILT IN HAND SHOWER		1.100
<b>SIF</b>	<b>SIFONE SCARICO VASCA</b> PLASTIC SIPHON	40	

# Gen-y Top 120 x 70 x 215h

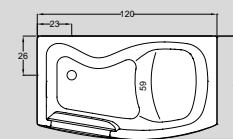
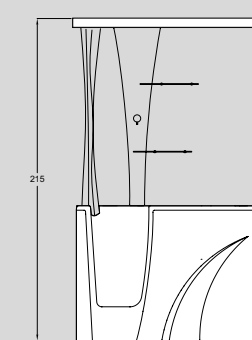

Scheda tecnica disponibile sul sito [www.gruppotes.it](http://www.gruppotes.it)  
 Technical drawing available on [www.gruppotes.it](http://www.gruppotes.it)

## INSTALLAZIONE / INSTALLATION

DISPONIBILE ANCHE NELLE VERSIONI: 5 - 6 - 7 - 8 (RIFERIMENTO PAG 2)

AVAILABLE ALSO IN VERSIONS: 5 - 6 - 7 - 8 (REF. PAGE 2)

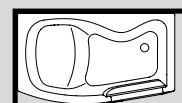

1(SX)

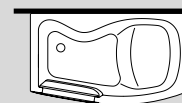

2(DX)

MODELLO MODEL	ARTICOLO ARTICLE	DESCRIZIONE DESCRIPTION	
<b>VASCA CON TELAIO+PANNELLO+SISTEMA DOCCIA - BATHTUB WITH CHASSIS+PANEL+SHOWER SYSTEM</b>			
<b>VTL</b>	<b>V3411</b> (VASCA) <b>B3411</b> (BOX)	<b>SENZA IDROMASSAGGIO + SISTEMA DOCCIA</b> WITHOUT WHIRLPOOL + SHOWER SYSTEM	<b>6.000</b>
<b>VASCA CON IDROMASSAGGIO+PANNELLO+SISTEMA DOCCIA - BATHTUB WITH WHIRLPOOL + PANEL+SHOWER SYSTEM</b>			
<b>STD</b>	<b>STANDARD DIGITALE</b> <b>V3417</b> (VASCA) <b>B3411</b> (BOX)	<b>IDROMASSAGGIO CON AVVIAMENTO DIGITALE + SISTEMA DOCCIA</b> WHIRLPOOL WITH DIGITAL START + SHOWER SYSTEM	<b>7.000</b>

## PANNELLI PER VASCA - PANELS FOR BATHTUB

	<b>V341 D/S</b>	<b>PANNELLO LATERALE DESTRO O SINISTRO</b> RIGHT OR LEFT SIDE PANEL	<b>300</b>
--	-----------------	--	------------

DOTAZIONI VASCA BATHTUB SUPPLY	VTL	STD
• JET IDROMASSAGGIO - WHIRLPOOL JET	—	8
• COLONNA DI SCARICO CON EROGAZIONE - DRAIN COLUMN WITH WATER OUTLET	●	●
• MISCELATORE MONOCOMANDO CON DEVIATORE E DOCCETTA - SINGLE-LEVER MIXER WITH DIVERTER AND SHOWER-HEAD	●	●
• SENSORE DI LIVELLO - LEVEL SENSOR	—	●
• PANNELLO FRONTALE - FRONTAL PANEL	●	●
• MASSIMO CONTENUTO ACQUA - MAX WATER CAPACITY	270 LT.	270 LT.

LEGENDA - LEGEND ● Di serie - Of series — Non disponibile - Not available

DOTAZIONI DOCCIA SHOWER SUPPLY	
• SCORREVOLE IN ACCIAIO E TENDA DOCCIA IN TESSUTO CON ANELLI / STAINLESS STEEL RAIL WITH WATERPROOF FABRIC CURTAIN WITH RINGS	●
• MISCELATORE MONOCOMANDO CON DEVIATORE / SINGLE-LEVER MIXER WITH DIVERTER	●
• TETTO CON DOCCIONE / MULTI-FUNCTION SHOWER CEILING WITH SHOWER HEAD	●
• N° 2 MENSOLE PORTAOGGETTI / N° 2 GLASS SHELVES	●

	OPTIONAL VASCA BATHTUB OPTIONALS	VTL	STD
STATA	STABILIZZATORE TEMPERATURA ACQUA - WATER TEMPERATURE STABILIZER	—	600
*SVUO	SVUOTAMENTO RAPIDO - RAPID EMPTYING	650	650
CROMO	CROMOTERAPIA - CHROMOTHERAPY	—	700
BORDO	KIT PROFILO BORDO VASCA - BATHTUB EDGE SKIRTING KIT	50	50

\*ATTENZIONE: LO SVUOTAMENTO RAPIDO SI PUÒ INSERIRE SOLO SE LO SCARICO DELLA VASCA È DIRETTO, SENZA PASSARE PER SCATOLE SIFONATE.  
ATTENTION: THE RAPID EMPTYING CAN BE POSSIBLE ONLY IF THE DISCHARGE IS DIRECTED, WITHOUT TO PASS FOR SIPHON BOXES.

	OPTIONAL DOCCIA SHOWER OPTIONALS	CROMO CHROME
DOCCI	DOCCIONE AGGIUNTIVO - ADDITIONAL BLOW - PIPE	350

	RUBINETTERIA TAPS	CROMO CHROME
RUE	SUPPLEMENTO RUBINETTERIA ELETTRONICA CON DEVIATORE E DOCCETTA SEMI-INCASSO SURCHARGE ELECTRONIC WATER TAPS WITH DIVERTER AND SEMI-BUILT IN HAND SHOWER	1.100
SIF	SIFONE SCARICO VASCA PLASTIC SIPHON	40



# Sistema doccia

## *Shower cubicles*

<b>ACQUAZZURRA 80/100</b>	60
<b>ACQUAZZURRA 90 S</b>	61
<b>ACQUAZZURRA 100 S</b>	62

# Acquazzurra 80/100

80 x 100 x 220h



Scheda tecnica disponibile sul sito [www.gruppotres.it](http://www.gruppotres.it)  
 Technical drawing available on [www.gruppotres.it](http://www.gruppotres.it)

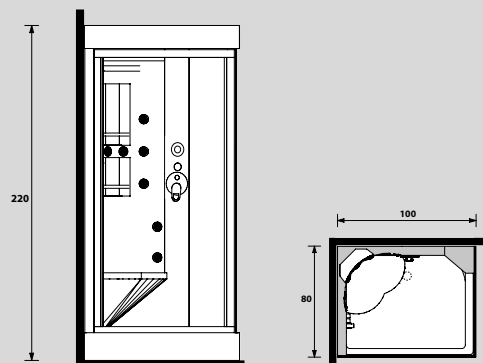

## INSTALLAZIONE / INSTALLATION

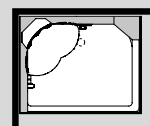

(SX)

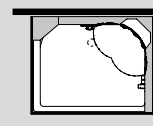

(DX)

MODELLO MODEL	ARTICOLO ARTICLE	DESCRIZIONE DESCRIPTION	
<b>IDROMASSAGGIO - HYDROMASSAGE</b>			
<b>STI</b>	<b>B7536</b>	<b>IDROMASSAGGIO WHIRLPOOL</b>	<b>3.700</b>
<b>IDROMASSAGGIO + BAGNO TURCO - HYDROMASSAGE + STEAM BATH</b>			
<b>STB</b>	<b>B7537</b>	<b>IDROMASSAGGIO E BAGNO TURCO MONOCLIMA WHIRLPOOL AND MONO-CLIMATE STEAM BATH</b>	<b>4.600</b>

	OPTIONAL DOCCIA SHOWER OPTIONALS	STI	STB
<b>CROMO</b>	<b>CROMOTERAPIA - CHROMOTHERAPY</b>	<b>700</b>	<b>700</b>
<b>FARET</b>	<b>FARO - LAMP</b>	<b>350</b>	<b>350</b>
<b>TERMO</b>	<b>RUBINETTO TERMOSTATICO - THERMOSTATIC TAP</b>	<b>300</b>	<b>300</b>
<b>DOCCI</b>	<b>DOCCIONE - BLOW-PIPE</b>	<b>300</b>	<b>300</b>

DOTAZIONI DOCCIA SHOWER SUPPLY	STI	STB
• <b>JET MASSAGGIO VERTICALE - VERTICAL WHIRLPOOL JETS</b>	<b>10</b>	<b>10</b>
• <b>JET MASSAGGIO CERVICALE - CERVICAL WHIRLPOOL JETS</b>	<b>3</b>	<b>3</b>
• <b>BAGNO TURCO - STEAM BATH</b>	—	●
• <b>MISCELATORE CON SELETTORE MULTIFUNZIONE - MIXER WITH MULTIFUNCTION SELECTOR</b>	●	●
• <b>ASTA SALISCENDI CON DOCCETTA - RISE AND FALL POST WITH SHOWER-HEAD</b>	●	●
• <b>RIPIANO PORTA OGGETTI - OBJECT-HOLDER SHELF</b>	<b>2</b>	<b>2</b>
• <b>CHIUSURA IN CRISTALLO DA 6MM CON PROFILI CROMO - CRYSTAL-GLASS 6 MM FASTENER WITH FINISH CHROME PROFILES</b>	●	●
• <b>PILETTA DI SCARICO - DRAIN PIPE</b>	●	●
• <b>SPERCHIO INTERNO - INSIDE MIRROR</b>	<b>1</b>	<b>1</b>

### LEGENDA - LEGEND

- Di serie - Of series
- Non disponibile - Not available

# Acquazzurra 90 S 90 x 90 x 220h

61



Scheda tecnica disponibile sul sito [www.gruppotes.it](http://www.gruppotes.it)  
 Technical drawing available on [www.gruppotes.it](http://www.gruppotes.it)

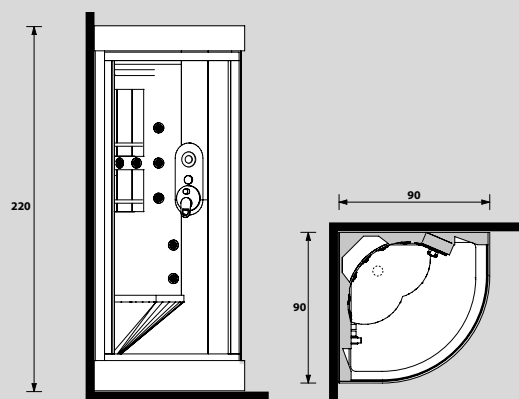

## INSTALLAZIONE / INSTALLATION

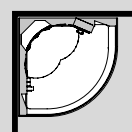

(SX)

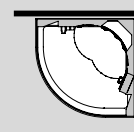

(DX)

MODELLO MODEL	ARTICOLO ARTICLE	DESCRIZIONE DESCRIPTION	
<b>IDROMASSAGGIO - HYDROMASSAGE</b>			
<b>STI</b>	<b>B7596</b>	<b>IDROMASSAGGIO WHIRLPOOL</b>	<b>3.500</b>
<b>IDROMASSAGGIO + BAGNO TURCO - HYDROMASSAGE + STEAM BATH</b>			
<b>STB</b>	<b>B7597</b>	<b>IDROMASSAGGIO E BAGNO TURCO MONOCLIMA WHIRLPOOL AND MONO-CLIMATE STEAM BATH</b>	<b>4.400</b>

<b>OPTIONAL DOCCIA SHOWER OPTIONALS</b>		<b>STI</b>	<b>STB</b>
<b>CROMO</b>	<b>CROMOTERAPIA - CHROMOTHERAPY</b>	<b>700</b>	<b>700</b>
<b>FARET</b>	<b>FARO - LAMP</b>	<b>350</b>	<b>350</b>
<b>TERMO</b>	<b>RUBINETTO TERMOSTATICO - THERMOSTATIC TAP</b>	<b>300</b>	<b>300</b>
<b>DOCCI</b>	<b>DOCCIONE - BLOW-PIPE</b>	<b>300</b>	<b>300</b>

<b>DOTAZIONI DOCCIA SHOWER SUPPLY</b>	<b>STI</b>	<b>STB</b>
• <b>JET MASSAGGIO VERTICALE - VERTICAL WHIRLPOOL JETS</b>	<b>10</b>	<b>10</b>
• <b>JET MASSAGGIO CERVICALE - CERVICAL WHIRLPOOL JETS</b>	<b>3</b>	<b>3</b>
• <b>BAGNO TURCO - STEAM BATH</b>	—	●
• <b>MISCELATORE CON DEVIATORE - MIXER WITH DIVERTER</b>	●	●
• <b>ASTA SALISCENDI CON DOCCETTA - RISE AND FALL POST WITH SHOWER-HEAD</b>	●	●
• <b>RIPIANO PORTA OGGETTI - OBJECT-HOLDER SHELF</b>	<b>2</b>	<b>2</b>
• <b>CHIUSURA IN CRISTALLO DA 6MM CON PROFILI CROMO - CRYSTAL-GLASS 6 MM FASTENER WITH FINISH CHROME PROFILES</b>	●	●
• <b>PILETTA DI SCARICO - DRAIN PIPE</b>	●	●
• <b>SPECCHIO INTERNO - INSIDE MIRROR</b>	<b>2</b>	<b>2</b>

### LEGENDA - LEGEND

- **Di serie - Of series**
- **Non disponibile - Not available**

# Acquazzurra 100 S 100 x 100 x 220h



Scheda tecnica disponibile sul sito [www.gruppotres.it](http://www.gruppotres.it)  
 Technical drawing available on [www.gruppotres.it](http://www.gruppotres.it)

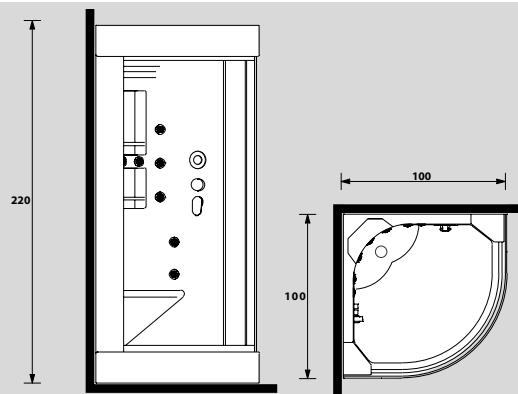

## INSTALLAZIONE / INSTALLATION

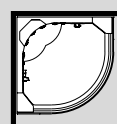

(SX)

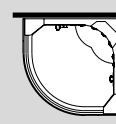

(DX)

MODELLO MODEL	ARTICOLO ARTICLE	DESCRIZIONE DESCRIPTION	
<b>IDROMASSAGGIO - HYDROMASSAGE</b>			
<b>STI</b>	<b>B7516</b>	<b>IDROMASSAGGIO WHIRLPOOL</b>	<b>4.000</b>
<b>IDROMASSAGGIO + BAGNO TURCO - HYDROMASSAGE + STEAM BATH</b>			
<b>STB</b>	<b>B7517</b>	<b>IDROMASSAGGIO E BAGNO TURCO MONOCLIMA WHIRLPOOL AND MONO-CLIMATE STEAM BATH</b>	<b>4.800</b>

OPTIONAL DOCCIA SHOWER OPTIONALS		STI	STB
<b>CROMO</b>	<b>CROMOTERAPIA - CHROMOTHERAPY</b>	<b>700</b>	<b>700</b>
<b>FARET</b>	<b>FARO - LAMP</b>	<b>350</b>	<b>350</b>
<b>TERMO</b>	<b>RUBINETTO TERMOSTATICO - THERMOSTATIC TAP</b>	<b>300</b>	<b>300</b>
<b>DOCCI</b>	<b>DOCCIONE - BLOW-PIPE</b>	<b>300</b>	<b>300</b>

DOTAZIONI DOCCIA SHOWER SUPPLY	STI	STB
• <b>JET MASSAGGIO VERTICALE - VERTICAL WHIRLPOOL JETS</b>	<b>10</b>	<b>10</b>
• <b>JET MASSAGGIO CERVICALE - CERVICAL WHIRLPOOL JETS</b>	<b>3</b>	<b>3</b>
• <b>BAGNO TURCO - STEAM BATH</b>	—	●
• <b>MISCELATORE CON DEVIATORE - MIXER WITH DIVERTER</b>	●	●
• <b>ASTA SALISCENDI CON DOCCETTA - RISE AND FALL POST WITH SHOWER-HEAD</b>	●	●
• <b>RIPIANO PORTA OGGETTI - OBJECT-HOLDER SHELF</b>	<b>2</b>	<b>2</b>
• <b>CHIUSURA IN CRISTALLO DA 6MM CON PROFILI CROMO - CRYSTAL-GLASS 6 MM FASTENER WITH FINISH CHROME PROFILES</b>	●	●
• <b>PILETTA DI SCARICO - DRAIN PIPE</b>	●	●
• <b>SPECCHIO INTERNO - INSIDE MIRROR</b>	<b>2</b>	<b>2</b>

### LEGENDA - LEGEND

- Di serie - Of series
- Non disponibile - Not available



# Condizioni di vendita *Terms of sale*

Il presente listino annulla ogni precedente.

**ORDINI** Ogni ordine è impegnativo per il Committente, mentre ha valore di semplice proposta per la società Gruppo Tre S Spa che rimane, a sua volta impegnata con la sua conferma scritta di accettazione.

**ANNULLAMENTO ORDINE** L'ordine non può essere revocato dopo la conclusione del contratto, la società Gruppo Tre S Spa si riserva comunque di addebitare la spesa e gli oneri conseguenti.

**ORDINE ERRATO** Il materiale oggetto dell'ordine non può essere reso alla società Gruppo Tre S Spa se non dopo una sua accettazione scritta. Rimangono comunque a carico del Committente le spese di trasporto ed un importo pari al 25% del valore dell'ordine quale ordine di reimmagazzinaggio.

**ORDINI SPECIALI** L'ordine dei prodotti non a listino deve essere accompagnato da un acconto pari al 20% del valore del prodotto richiesto. Per tali prodotti la società Gruppo Tre S Spa non accetta alcun reso.

**TERMINI DI CONSEGNA** i termini di consegna sono puramente indicativi e non impegnativi.

**PREZZI** I prezzi di vendita sono quelli riportati sul listino vigente al momento della stipulazione del contratto e si intendono per forniture franco stabilimento di Nepi (VT) Italia. I prezzi sono indicati in Euro. Sono escluse, dal prezzo di vendita, tutte le spese e gli oneri accessori (trasporto, tasse, Iva, montaggi, ecc.) che rimangono a carico del Committente. La società Gruppo Tre S Spa si riserva la facoltà di variare i propri listini senza l'obbligo di preavviso. Tutti gli ordini ricevuti dopo l'avvenuta variazione, nonché tutte le spedizioni programmate oltre i 30 gg. dalla comunicazione di variazione, sono soggetti ai nuovi prezzi.

**PAGAMENTI** Le condizioni di pagamento, se non diversamente specificate e approvate dalla società Gruppo Tre S Spa, sono: a) Vendite nazionali: IVA a 30gg.: resto a seconda del credito concesso; b) Vendite all'estero: lettera di credito irrevocabile, confermata da una banca di primaria importanza. L'insorgere di qualsiasi controversia non esime il Committente dall'obbligo di pagare il prezzo pattuito secondo le condizioni convenute. Nessuna domanda o difesa può essere proposta in giudizio dal Committente qualora questi sia in mora con i pagamenti. Il ritardo, anche parziale del pagamento, genera la decorrenza degli interessi di mora calcolati nella misura del prime rate corrente aumentato di cinque (5) punti a far data dall'emissione della fattura.

**RISERVA DI PROPRIETÀ** La presente vendita è eseguita con riserva di proprietà ( art. 1523 e seguenti C.C.), pertanto i prodotti rimangono di proprietà della società Gruppo Tre S Spa fino all'integrale pagamento del prezzo.

**PROGETTAZIONE** La società Gruppo Tre S Spa si riserva il diritto di cessare la produzione, senza preavviso, di qualsiasi modello e/o introdurre modifiche, senza per questo essere in obbligo di effettuare tali modifiche sui prodotti precedentemente forniti.

**FATTURAZIONE MINIMA** Qualsiasi ordine con importo inferiore a 500 EURO verrà regolarizzato con pagamento in contrassegno e verranno sempre addebitate euro 50 per spese di trasporto.

**IMBALLO** la merce viaggia in imballi in cartone compresi nel prezzo di vendita per trasporti via terra e su automezzi. Nessuno sconto è concesso per merce spedita o consegnata senza imballo, imballi diversi verranno fatturati al costo.

**TRASPORTO** La merce, che viaggia a rischio e pericolo del Committente, viene resa franco stabilimento di Nepi. Non vengono accettati indirizzi diversi dalla sede commerciale del cliente. La bolla di accompagnamento firmata al momento dello scarico vale come dichiarazione di esatta corrispondenza di quanto in essa elencato. I reclami saranno accettati solo se verranno inoltrati entro 2 giorni dalla data di consegna a mezzo raccomandata con ricevuta di ritorno.

**RESI** I resi di materiale devono essere preventivamente autorizzati dalla società Gruppo Tre S Spa a condizioni che si tratti di prodotti nuovi, mai usati e di modelli ancora in produzione presso la società Gruppo Tre S Spa e che i medesimi non siano stati consegnati da più di 12 mesi. I prodotti non a listino (speciali, consegnati su specifica richiesta del Committente) non possono essere restituiti. Le spese di trasporto sono a carico del Committente sul quale graverà l'onere di reimmagazzinaggio pari al 25% del valore del materiale reso alla data dell'acquisto.

**GARANZIA** Tutti i prodotti del Gruppo Tre S, secondo quanto stabilito dal Codice del Consumo, sono coperti da una garanzia convenzionale di 2 anni ( 1 anno nel caso di acquisti professionali). Nel caso di richiesta di interventi in garanzia sui prodotti tenuti a stock o in esposizione presso sale mostra, che abbiano superato i 24 mesi dalla consegna o che comunque siano stati prodotti da più di 36 mesi (vedi etichetta di produzione all'interno della garanzia), non è previsto diritto ad intervenire in garanzia se non in seguito ad accordo specifico tra le parti. La garanzia è valida solo per prodotti acquistati ed installati nel territorio italiano Vedi condizioni e certificato di garanzia allegato al prodotto per tutto quanto non espressamente specificato.

**FORO COMPETENTE** Per qualsiasi controversia è esclusivamente competente il Foro di Roma applicabile anche in deroga alle norme dei Paesi esteri la legislazione Italiana. Permane la competenza del Foro di Roma anche se il pagamento sia pattuito a mezzo effetti cambiari. Il committente dichiara di ben conoscere ed accettare tutte le condizioni di vendita sopra elencate ed in particolare accetta e conferma ai sensi dell' art. 1341 C.C. la garanzia e le seguenti clausole: Ordini, Annullamento ordine, Ordine errato, Ordini speciali, Termini di consegna, Prezzi, Pagamenti, Riserva di proprietà, Progettazione, Fatturazione minima, Imballo, Trasporto, Resi.

This price-list annuls all previous ones.

**ORDERS** Every order is binding for the Purchaser, while it has the value of proposal for Gruppo Tre S Spa who is in turn committed by its written confirmation of acceptance.

**ORDER CANCELLING** An order cannot be revoked after the execution of the contract. At events, Gruppo Tre S Spa reserves to charge any consequent expenses and costs.

**MISTAKEN ORDER** Material ordered cannot be returned to Gruppo Tre S Spa except after written acceptance. The Purchaser will be charged with transport expenses and 25% of the value of the order for coverage of re-storage fees.

**SPECIAL ORDERS** An order for products not included in the price-list must be accompanied by a down payment of 20% of the value of the product requested. Gruppo Tre S Spa accepts no returns for these products.

**TERMS OF DELIVERY** The terms of delivery are indicative only and not binding.

**PRICES** The sale prices are those given in the current price-list at the time of execution of the contract and are for ex Nepi works (VT) Italy supplies. Prices are indicated. The sale price does not include any expenses and charges (transport, tax, vat, assembly, etc.) which are at the customer's expense. Gruppo Tre S reserves the faculty to change its price-list without prior notice. All orders received after a change, and all shipments scheduled over 30 days from the notice of a change, are subject to the new prices.

**PAYMENTS** If not otherwise specified and approved by Gruppo Tre S Spa, the terms of payment are the following:

A) National sales: VAT 30 days; remainder according to the granted credit.

B) Foreign sales: irrevocable letter of credit confirmed by a leading bank.

Any dispute will not exempt the Purchaser from settling the agreed price according to the agreed terms. The Customer may not start legal proceedings if in arrears with payments. Any delay, even partial, will cause interest on delayed payment calculated on the amount of the first current instalments increased by five (5) points as from the date of issue of the invoice.

**CONDITIONAL SALE** This is a conditional sale (art.1523 and following of the Civil Code), therefore, the products remain the property of Gruppo Tre S Spa until the price has been paid in full.

**DESIGN** Gruppo Tre S Spa reserves the right to cease the production of any model and/or bring about changes without prior notice and without being obliged to make such changes on products supplied previously.

**MINIMUM INVOICE AMOUNT** Any amount under 500,00 must be paid upon delivery.

**PACKING** Goods travel in cardboard packaging which is included in the cost of land transport. No discount is given for goods dispatched or delivered without packaging. Other packaging will be invoiced at cost.

**TRANSPORT** The goods travel at the Purchaser's risk and peril on an ex Nepi works basis. Addresses other than the purchaser's business address are not accepted. The delivery note signed at the time of unloading is valid as certification that the goods correspond exactly to the items listed on it. Claims will only be accepted if they are forwarded within 2 days of the date of delivery by registered mail with notice of receipt.

**RETURNS** Returns of material must be authorized beforehand by Gruppo Tre S Spa, provided that they are new products which have never been used and models still being manufactured by Gruppo Tre S Spa and that were not delivered over 12 months before. Products not included in the price-list (special products, delivered against specific Purchaser's request) may not be returned. Transport expenses are to be paid by the Customer in addition to a re-storage fee amounting to 25% of the value of the returned material at the date of purchase.

**GUARANTEE** All Gruppo Tre S products are covered by a 2-year warranty (1 year for professional purchases), in accordance with the dispositions of the Consumer Code. Requests for replacements/repairs under warranty, in relation to products in stock or exhibited in show rooms, over 24 months from their delivery or, in any case, over 36 months from their production date (see production label in the warranty), will not be accepted, unless the parties have specifically agreed otherwise. The warranty is valid only for products bought and installed in Italy.

For any matters not expressly specified, please see the conditions and warranty issued with the product.

**COURT OF JURISDICTION** For any dispute, the only court of jurisdiction is the Court of Roma according to Italian law not with standing the provisions of the laws of foreign countries. The court of jurisdiction is still Roma even if payment has been arranged by bills of exchange. The purchaser declares to be well aware of and to accept all the terms of sale listed above and in particular he accepts and confirms the guarantee and the following clauses as per art. 1341 of the Civil Code: Orders, Order cancelling, Mistaken order, Special orders, Terms of delivery, Prices, Payments, Conditional sale, Design, Minimum billing, Transport, Returns.

treesse  
www.gruppotreesse.it



GRUPPO TRE S.s.p.a.

Sede legale - Registered office  
Via Cassia, 698  
00189 Roma (RM) Italia

Sede operativa - Operational headquarters  
Via degli Imprenditori, 8-10  
Zona industriale Settevene  
01036 Nepi (VT) Italia  
Tel. (+39) 0761 527242  
Fax (+39) 0761 1765419  
info@gruppotres.it

