

treesse

Design for lifestyle

LISTINO PREZZI _ PRICE LIST
MARZO _ MARCH 2025

ÉLITE

Indice - Index

Informazioni generali per l'utilizzo del listino vasche 2
General information on the use of this price-list bathtub

Informazioni generali per l'utilizzo del listino saune 3
General information on the use of this price-list saune

Impianti vasche idromassaggio 4
Whirlpool bathtub system

Rubinetteria 5
Taps

Ghost	
DREAM 160	8
DREAM 170	10
DREAM 180	12
DREAM 181	14
DREAM 190	16
DREAM 199	18
DREAM 200	20
FUSION 200	22
FUSION 230	24
FUSION 231	26
SOUL 120	28
SOUL 150	30

Vasche Freestanding - Freestanding Bathtubs

ALMA	34
BALI	36
BRIO	38
CALIDA	40
CAMELIA	42
CAREZZA 170	44
CAREZZA 180	46
CLIVIA 160	48
CLIVIA 170	50
CORA	52
CROSS	54
EPOCA	56
GRAND SOLEIL	58
ILIA	60
INKA 150	62
INKA 180	64
NIÑA	66
VERA	68
VIVA	70

Vasche Standard - Standard Bathtubs

BIS	74
EOS 160	76
EOS 190	78
QUADRA 170	80
QUADRA 180	82
QUADRA 181	84
QUADRA 199	86

Saune/Hammam - Saune/Hammam

AURA (VETRO FRONTALE/FRONT GLASS)	90
AURA (CON VETRO LATERALE/WITH LATERAL GLASS)	91
MIRAGE	92

Sistemi audio - Audio system

BIG-BANG	95
----------	----

CONDIZIONI DI VENDITA - TERMS OF SALE	96
---------------------------------------	----

Informazioni generali per l'utilizzo del listino vasche

General information on the use of this bathtub price-list

DIMENSIONI / DIMENSIONS

Tutte le misure sono espresse in centimetri.

Dimension are given in centimeters.

COLORE / COLOUR

I prezzi del listino si riferiscono a vasche di colore bianco.

Listed price refer to white bathtubs.

MODALITÀ D'ORDINE / ORDERING PROCEDURES

- 1) Scegliere l'articolo in base alla forma e dimensione.
- 2) Scegliere la tipologia di impianto.
- 3) Scegliere il verso di installazione in base alle proprie esigenze, facendo riferimento alla tabella riportata di seguito al presente testo.
- 4) Scegliere il colore delle finiture, eventuali optional, la rubinetteria (se desiderata) e relativo colore.

- 1) Choose the article based on shape and dimension.
- 2) Choose system type.
- 3) Choose installation direction based on your own needs, using the table below as reference.
- 4) Choose finishings colour, optionals, faucets (if desired) and relative colour.

INSTALLAZIONE VASCHE RETTANGOLARI / INSTALLATION RECTANGULAR BATHTUB

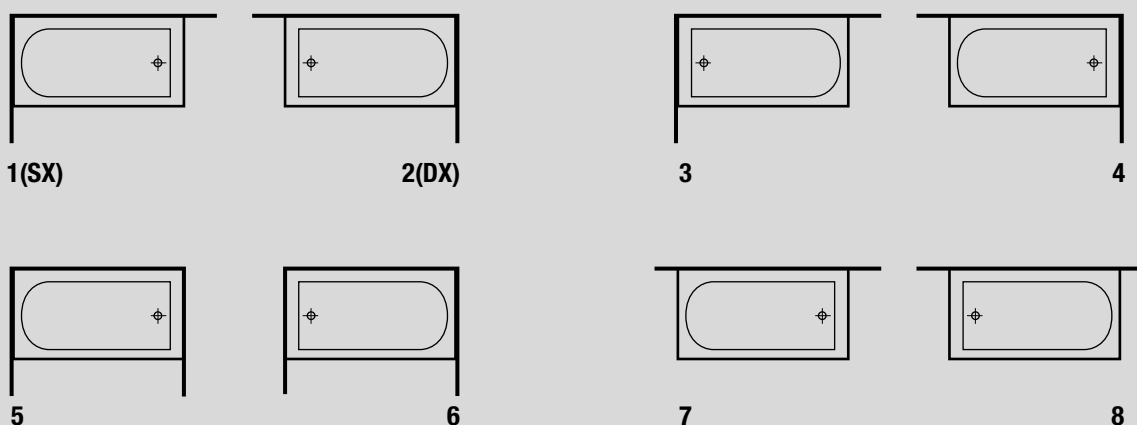

INSTALLAZIONE VASCHE ASIMMETRICHE / INSTALLATION ASYMMETRIC BATHTUB

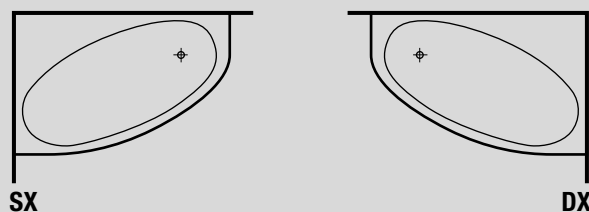

LIMITI DI RAPPRESENTATIVITÀ / SPECIFICATION LIMITS

I dati tecnici, le descrizioni e le rappresentazioni grafiche dei beni riportati sul presente listino, sono puramente indicativi. Le specifiche dimensionali e d'installazione sono riportate con esattezza sulle schede tecniche, consultabili sul sito www.gruppotreesse.it. L'azienda si riserva la facoltà di modificare la produzione a suo insindacabile giudizio, senza obbligo di preavviso.

Technical data, descriptions and graphic representations of the goods in this price-list are merely approximate. The dimensional and installation specifications are stated exactly on the technical information sheet, available on the website www.gruppotreesse.it. The firm reserves the right to modify its production at its sole discretion and without prior notice.

Informazioni generali per l'uso del listino saune 3

General information on the use of this sauna price-list

DIMENSIONI / DIMENSIONS

Tutte le misure sono espresse in centimetri.

Dimension are given in centimeters.

MODALITÀ D'ORDINE / ORDERING PROCEDURES

1) Scegliere l'articolo in base alla dimensione.

2) Scegliere la tipologia di sauna (1 lato vetro - 2 lati vetri).

3) Scegliere eventuali optional.

1) Choose the article based on dimension.

2) Choose the type of sauna (1 pane of glass - 2 panes of glass).

3) Choose optionals.

INSTALLAZIONE SAUNE - 1 LATO VETRO / 1 PANE OF GLASS

INSTALLAZIONE SAUNE - 2 LATI VETRI / 2 PANES OF GLASS

SX DX
A NICCHIA - NICHE



SX DX
ANGOLARE - CORNER

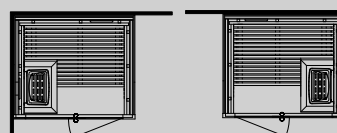

ANGOLARE - CORNER

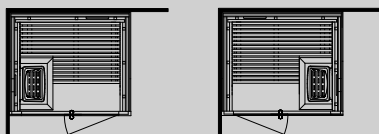

A PARETE- WALL

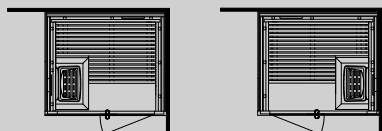
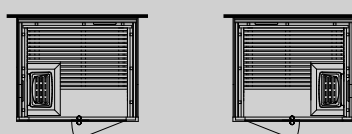

CENTRO STANZA - FREESTANDING

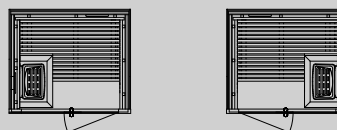

A PARETE- WALL

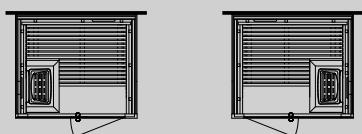

CENTRO STANZA - FREESTANDING

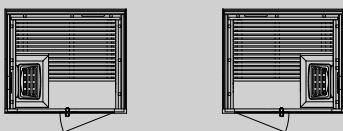

LIMITI DI RAPPRESENTATIVITÀ / SPECIFICATION LIMITS

I dati tecnici, le descrizioni e le rappresentazioni grafiche dei beni riportati sul presente listino, sono puramente indicativi.

Le specifiche dimensionali e d'installazione sono riportate con esattezza sulle schede tecniche, consultabili sul sito www.gruppotreese.it.

L'azienda si riserva la facoltà di modificare la produzione a suo insindacabile giudizio, senza obbligo di preavviso.

Technical data, descriptions and graphic representations of the goods in this price-list are merely approximate.

The dimensional and installation specifications are stated exactly on the technical information sheet, available on the website www.gruppotreese.it.

The firm reserves the right to modify its production at its sole discretion and without prior notice.

4 Impianti vasche idromassaggio

Whirlpool bathtub system

IDROMASSAGGIO

Impianto

STANDARD DIGITALE (STD)

- Pulsante digitale on/off per avviamento dell'impianto.
- Regolazione manuale del flusso dell'aria.
- Bocchette orientabili e chiudibili completamente.
- Sensore di livello.
- Temporizzatore di sicurezza per arresto automatico dell'impianto.

Impianto

STANDARD EXTRA (STX)

- Pulsante digitale on/off per avviamento dell'impianto.
- Regolazione digitale del flusso dell'aria.
- Bocchette orientabili e chiudibili completamente.
- Valvola motorizzata per regolazione dell'aria.
- Sensore di livello.
- Temporizzatore di sicurezza per arresto automatico dell'impianto.
- Faro subacqueo.

Impianto

SKIMMER SYSTEM (SKI)

- Comandi digitali per la funzione idromassaggio e ricircolo.
- Sensore di livello.
- Temporizzatore di sicurezza per arresto automatico dell'impianto.
- Sistema riempimento vasca automatico.
- Sistema svuotamento vasca elettronico.

Impianto

DIGITAL WHIRPOOL (AWC)

- Comandi digitali per la funzione idromassaggio.
- Sensore livello.
- Temporizzatore di sicurezza per arresto automatico dell'impianto.

Impianto DIGITAL WHIRLPOOL AND DRAIN CONTROL (AWD)

- Comandi digitali per la funzione idromassaggio.
- Sensore di livello.
- Temporizzatore di sicurezza per arresto automatico dell'impianto.
- Sistema svuotamento vasca elettronico.

WHIRPOOL

STANDARD DIGITAL system (STD)

- System digital on/off button for system start-up.
- Manual regulation of air flow.
- Nozzles can be completely oriented and closed.
- Level sensor.
- Safety timer for automatic stop.

STANDARD EXTRA system (STX)

- System digital on/off button for system start-up.
- Digital regulation of air flow.
- Nozzles can be completely oriented and closed.
- Motorized valve for air regulation.
- Level sensor.
- Safety timer for automatic stop.
- Underwater lamp.

SKIMMER system (SKI)

- Digital controls for whirlpool and recirculation.
- Level sensor.
- Safety timer for automatic stop.
- Automatic bathtub filling system.
- Electronic bathtub draining system.

DIGITAL WHIRPOOL (AWC)

- Digital commands for whirlpool.
- Level sensor.
- Safety timer for automatic stop.

DIGITAL WHIRLPOOL AND DRAIN CONTROL system (AWD)

- Digital commands for whirlpool.
- Level sensor.
- Safety timer for automatic stop.
- Electronic bathtub draining system.

IDROMASSAGGIO + AIRPOOL

Impianto DIGITAL WHIRPOOL AIRPOOL (AWA)

- Comandi digitali per le funzioni di idromassaggio ed airpool.
- Bocchette orientabili e chiudibili completamente.
- Funzione di Blowing After per lo svuotamento dall'acqua residua nell'impianto airpool a fine ciclo e asciugatura delle condotte. Il processo avviene a vasca vuota.
- Sensore di livello.
- Temporizzatore di sicurezza per arresto automatico dell'impianto.
- Faro subacqueo.

Impianto DIGITAL WHIRLPOOL/AIRPOOL AND DRAIN CONTROL (AAD)

- Comandi digitali per le funzioni idromassaggio e airpool.
- Sensore di livello.
- Temporizzatore di sicurezza per arresto automatico dell'impianto.
- Sistema svuotamento vasca elettronico.
- Funzione di Blowing After per lo svuotamento dall'acqua residua nell'impianto airpool a fine ciclo e asciugatura delle condotte. Il processo avviene a vasca vuota.

WHIRPOOL + AIRPOOL

DIGITAL WHIRPOOL AIRPOOL system (AWA)

- Digital commands for whirlpool and airpool.
- Nozzles can be completely oriented and closed.
- Blowing After function to drain remaining water once the cycle is over and to dry the pipes. The process takes place while the tub is empty.
- Level sensor.
- Safety timer for automatic stop.
- Underwater lamp.

DIGITAL WHIRLPOOL/AIRPOOL AND DRAIN CONTROL system (AAD)

- Digital commands for whirlpool and airpool.
- Level sensor.
- Safety timer for automatic stop.
- Electronic bathtub draining system.
- Blowing After function to drain remaining water once the cycle is over and to dry the pipes. The process takes place while the tub is empty.

MIX



Miscelatore monocomando con deviatore e doccia
Single-lever mixer with diverter and hand-shower

LINE

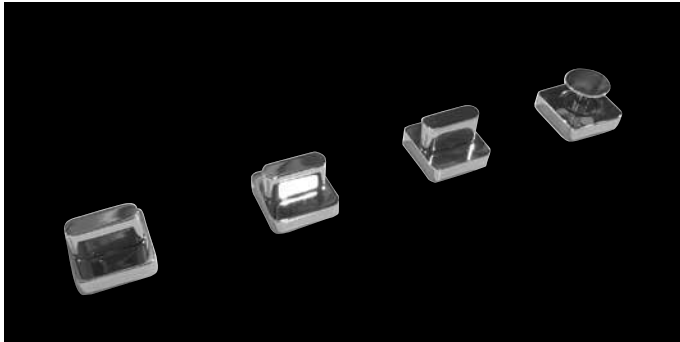

Rubineria acqua calda/fredda con deviatore e doccia semi-incasso
Hot/cold water taps with diverter and semi-built in hand shower

BOCCHEROGAZIONE / WATERFALL SPOUTS

BVG

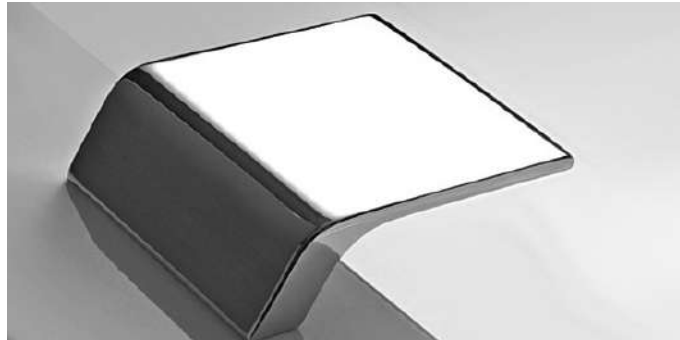

Bocca a vela grande
Large sail-shaped

BVC

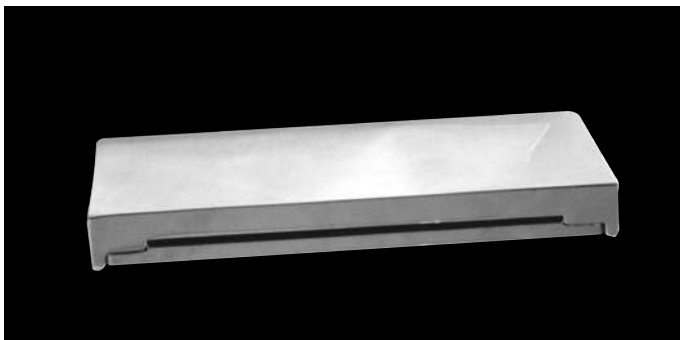

Bocca a vela piccola modello cubo
Small sail-shaped Cubo model

MLQ

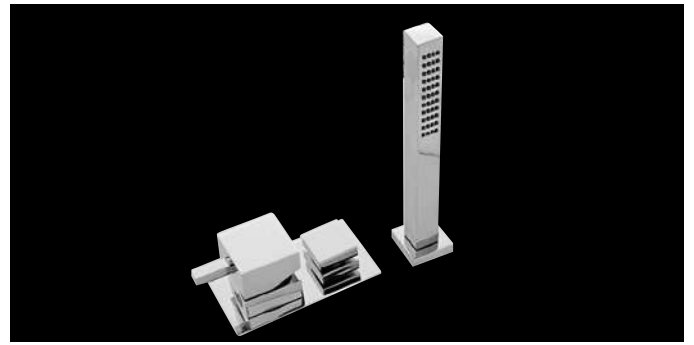

Miscelatore monocomando quadrato con deviatore e doccia
Squared single-lever mixer with diverter and hand-shower

RUE

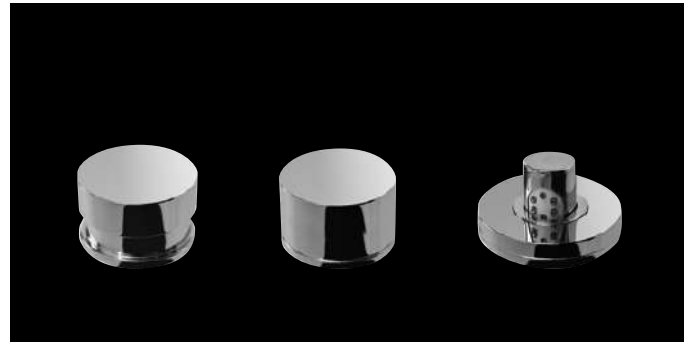

Rubineria elettronica con deviatore doccia semi-incasso
Electronic water taps with diverter and semi-built in hand shower

BVP



Bocca a vela piccola
Small sail-shaped

DREAM 160	8
DREAM 170	10
DREAM 180	12
DREAM 181	14
DREAM 190	16
DREAM 199	18
DREAM 200	20
FUSION 200	22
FUSION 230	24
FUSION 231	26
SOUL 120	28
SOUL 150	30

8 Dream 160 $\varnothing 160 \times 66h$

(GHOST®)

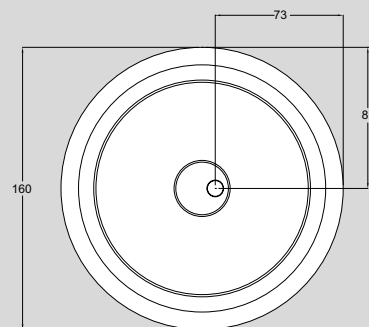
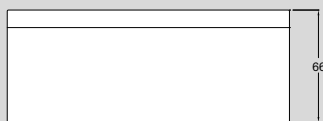

Scheda tecnica disponibile sul sito www.gruppotes.it
 Technical drawing available on www.gruppotes.it

INSTALLAZIONE / INSTALLATION

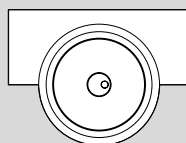

SEMI INCASSO / SEMI BUILT-IN

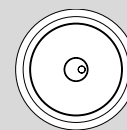

CENTROSTANZA / FREESTANDING

MODELLO MODEL	ARTICOLO ARTICLE	DESCRIZIONE DESCRIPTION		
VASCA CON TELAIO - BATHTUB WITH FRAME				
VTL	V8361	SENZA IDROMASSAGGIO WITHOUT WHIRLPOOL	5.200	
VASCA CON IDROMASSAGGIO GHOST - BATHTUB WITH GHOST WHIRLPOOL				
AWC	DIGITAL WHIRLPOOL CONTROL	V836F	IDROMASSAGGIO CON IMPIANTO DIGITALE WHIRLPOOL WITH DIGITAL SYSTEM	7.200

PANNELLI PER VASCA - PANELS FOR BATHTUB

	V836FX	PANNELLO PER INSTALLAZIONE SEMI INCASSO PANEL FOR SEMI BUILT-IN INSTALLATION	450
	V836FX 2	PANNELLI PER INSTALLAZIONE CENTRO STANZA PANELS FOR FREESTANDING INSTALLATION	900

DOTAZIONI VASCA BATHTUB SUPPLY	VTL	AWC
• JET IDROMASSAGGIO - WHIRLPOOL JET	—	18
• COLONNA DI SCARICO - DRAIN COLUMN	●	●
• SENSORE DI LIVELLO - LEVEL SENSOR	—	●
• MASSIMO CONTENUTO ACQUA - MAX WATER CAPACITY	300 LT.	300 LT.

LEGENDA - LEGEND

- Di serie - Of series
- Non disponibile - Not available

	OPTIONAL VASCA BATHTUB OPTIONALS	VTL	AWC
STATA	STABILIZZATORE TEMPERATURA ACQUA - WATER TEMPERATURE STABILIZER	—	600
CROLED	CROMOTERAPIA CON LED SINGOLI PERIMETRALI - CHROMOTHERAPY WITH SINGLE PERIMETER LEDS	1.500	1.500
SOL	SOLLEVATORE PNEUMATICO PER VASCA INCASSO - PNEUMATIC LIFT FOR BUILT-IN BATHTUB	4.500	4.500

	RUBINETTERIA TAPS		CROMO CHROME
MIX	MISCELATORE MONOCOMANDO CON DEVIATORE E DOCCETTA SINGLE-LEVER MIXER WITH DIVERTER AND HAND-SHOWER		400
RUE	RUBINETTERIA ELETTRONICA CON DEVIATORE E DOCCETTA SEMI-INCASSO ELECTRONIC WATER TAPS WITH DIVERTER AND SEMI-BUILT IN HAND SHOWER		1.500
ERO	RIEMPIMENTO VASCA A SCOMPARSA HIDDEN FILLING		300
SIF	SIFONE SCARICO VASCA PLASTIC SIPHON	40	
FOR	SUPPLEMENTO PER FORATURA DIVERSA DA QUELLE PRESENTI SUL NOSTRO LISTINO SURCHARGE FOR TAPS DRILLING IF TAPS ARE NOT OUR MODELS	500	

Dream 170

170 x 70 x 65h

(GHOST®)

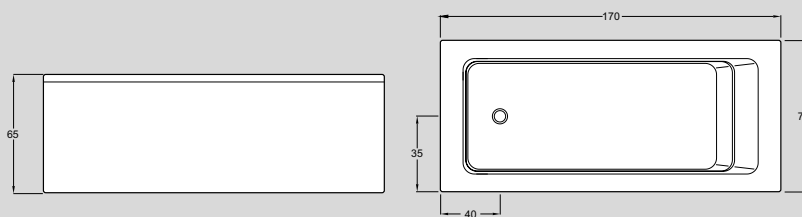

Scheda tecnica disponibile sul sito www.gruppotes.it
 Technical drawing available on www.gruppotes.it

INSTALLAZIONE / INSTALLATION

DISPONIBILE ANCHE NELLE VERSIONI: 3 - 4 - 5 - 6 - 7 - 8 (RIFERIMENTO PAG 2)

AVAILABLE ALSO IN VERSIONS: 3 - 4 - 5 - 6 - 7 - 8 (REF. PAGE 2)

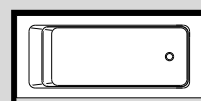

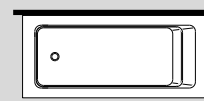

1(SX)



2(DX)

MODELLO MODEL	ARTICOLO ARTICLE	DESCRIZIONE DESCRIPTION		
VASCA CON TELAIO - BATHTUB WITH FRAME				
VTL	V8371	SENZA IDROMASSAGGIO WITHOUT WHIRLPOOL	2.600	
VASCA CON IDROMASSAGGIO GHOST - BATHTUB WITH GHOST WHIRLPOOL				
AWC	DIGITAL WHIRLPOOL CONTROL	V837F	IDROMASSAGGIO CON IMPIANTO DIGITALE WHIRLPOOL WITH DIGITAL SYSTEM	4.450

PANNELLI PER VASCA - PANELS FOR BATHTUB

	V077F	PANNELLO FRONTALE FRONTAL PANEL	350
	V077L D/S	PANNELLO LATERALE DESTRO O SINISTRO RIGHT OR LEFT SIDE PANEL	300

DOTAZIONI VASCA BATHTUB SUPPLY	VTL	AWC
• JET IDROMASSAGGIO - WHIRLPOOL JET	—	12
• CUSCINO POGGIATESTA MORBIDO NERO - SOFT PILLOW HEADREST BLACK	●	●
• COLONNA DI SCARICO - DRAIN COLUMN	●	●
• SENSORE DI LIVELLO - LEVEL SENSOR	—	●
• MASSIMO CONTENUTO ACQUA - MAX WATER CAPACITY	200 LT.	200 LT.

LEGENDA - LEGEND

- Di serie - Of series
- Non disponibile - Not available

	OPTIONAL VASCA BATHTUB OPTIONALS	VTL	AWC
STATA	STABILIZZATORE TEMPERATURA ACQUA - WATER TEMPERATURE STABILIZER	—	600
CROLED	CROMOTERAPIA CON LED SINGOLI PERIMETRALI - CHROMOTHERAPY WITH SINGLE PERIMETER LEDS	1.500	1.500
BORDO	KIT PROFILO BORDO VASCA - BATHTUB EDGE SKIRTING KIT	50	50

	RUBINETTERIA TAPS		CROMO CHROME
LINE	RUBINETTERIA ACQUA CALDA ACQUA FREDDA CON DEVIATORE E DOCCETTA SEMI-INCASSO HOT/COLD WATER TAPS WITH DIVERTER AND SEMI-BUILT IN HAND SHOWER		1.000
RUE	RUBINETTERIA ELETTRONICA CON DEVIATORE E DOCCETTA SEMI-INCASSO ELECTRONIC WATER TAPS WITH DIVERTER AND SEMI-BUILT IN HAND SHOWER		1.500
ERO	RIEMPIMENTO VASCA A SCOMPARSA HIDDEN FILLING		300
MLQ	MISCELATORE MONOCOMANDO QUADRATO CON DEVIATORE E DOCCETTA SQUARED SINGLE-LEVER MIXER WITH DIVERTER AND HAND-SHOWER		500
SIF	SIFONE SCARIGO VASCA PLASTIC SIPHON	40	
FOR	SUPPLEMENTO PER FORATURA DIVERSA DA QUELLE PRESENTI SUL NOSTRO LISTINO SURCHARGE FOR TAPS DRILLING IF TAPS ARE NOT OUR MODELS	500	

Dream 180

180 x 80 x 67h

(GHOST®)

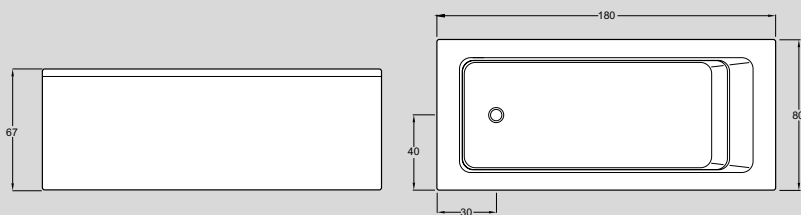

Scheda tecnica disponibile sul sito www.gruppotes.it
 Technical drawing available on www.gruppotes.it

INSTALLAZIONE / INSTALLATION

DISPONIBILE ANCHE NELLE VERSIONI: 3 - 4 - 5 - 6 - 7 - 8 (RIFERIMENTO PAG 2)

AVAILABLE ALSO IN VERSIONS: 3 - 4 - 5 - 6 - 7 - 8 (REF. PAGE 2)

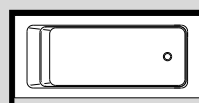

1(SX)



2(DX)

MODELLO MODEL	ARTICOLO ARTICLE	DESCRIZIONE DESCRIPTION		
VASCA CON TELAIO - BATHTUB WITH FRAME				
VTL	V8381	SENZA IDROMASSAGGIO WITHOUT WHIRLPOOL	2.800	
VASCA CON IDROMASSAGGIO GHOST - BATHTUB WITH GHOST WHIRLPOOL				
AWC	DIGITAL WHIRLPOOL CONTROL	V838F	IDROMASSAGGIO CON IMPIANTO DIGITALE WHIRLPOOL WITH DIGITAL SYSTEM	4.700

PANNELLI PER VASCA - PANELS FOR BATHTUB

	V078F	PANNELLO FRONTALE FRONTAL PANEL	350
	V078L D/S	PANNELLO LATERALE DESTRO O SINISTRO RIGHT OR LEFT SIDE PANEL	300

DOTAZIONI VASCA BATHTUB SUPPLY	VTL	AWC
• JET IDROMASSAGGIO - WHIRLPOOL JET	—	12
• CUSCINO POGGIATESTA MORBIDO NERO - SOFT PILLOW HEADREST BLACK	●	●
• COLONNA DI SCARICO - DRAIN COLUMN	●	●
• SENSORE DI LIVELLO - LEVEL SENSOR	—	●
• MASSIMO CONTENUTO ACQUA - MAX WATER CAPACITY	340 LT.	340 LT.

LEGENDA - LEGEND

- Di serie - Of series
- Non disponibile - Not available

	OPTIONAL VASCA BATHTUB OPTIONALS	VTL	AWC
STATA	STABILIZZATORE TEMPERATURA ACQUA - WATER TEMPERATURE STABILIZER	—	600
CROLED	CROMOTERAPIA CON LED SINGOLI PERIMETRALI - CHROMOTHERAPY WITH SINGLE PERIMETER LEDS	1.500	1.500
BORDO	KIT PROFILO BORDO VASCA - BATHTUB EDGE SKIRTING KIT	50	50

	RUBINETTERIA TAPS		CROMO CHROME
LINE	RUBINETTERIA ACQUA CALDA ACQUA FREDDA CON DEVIATORE E DOCCETTA SEMI-INCASSO HOT/COLD WATER TAPS WITH DIVERTER AND SEMI-BUILT IN HAND SHOWER		1.000
RUE	RUBINETTERIA ELETTRONICA CON DEVIATORE E DOCCETTA SEMI-INCASSO ELECTRONIC WATER TAPS WITH DIVERTER AND SEMI-BUILT IN HAND SHOWER		1.500
ERO	RIEMPIMENTO VASCA A SCOMPARSA HIDDEN FILLING		300
MLQ	MISCELATORE MONOCOMANDO QUADRATO CON DEVIATORE E DOCCETTA SQUARED SINGLE-LEVER MIXER WITH DIVERTER AND HAND-SHOWER		500
SIF	SIFONE SCARIGO VASCA PLASTIC SIPHON	40	
FOR	SUPPLEMENTO PER FORATURA DIVERSA DA QUELLE PRESENTI SUL NOSTRO LISTINO SURCHARGE FOR TAPS DRILLING IF TAPS ARE NOT OUR MODELS	500	

Dream 181

180 x 100 x 67h
(GHOST®)

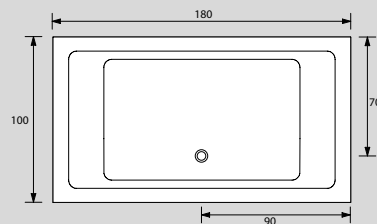

Scheda tecnica disponibile sul sito www.gruppotes.it
Technical drawing available on www.gruppotes.it

INSTALLAZIONE / INSTALLATION

DISPONIBILE ANCHE NELLE VERSIONI: 5 - 6 - 7 - 8 (RIFERIMENTO PAG 2)

AVAILABLE ALSO IN VERSIONS: 5 - 6 - 7 - 8 (REF. PAGE 2)

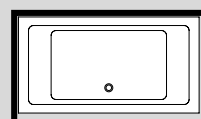

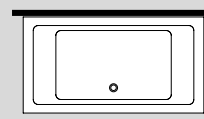

1(SX)



2(DX)

MODELLO MODEL	ARTICOLO ARTICLE	DESCRIZIONE DESCRIPTION	
VASCA CON TELAIO - BATHTUB WITH FRAME			
VTL	V8311	SENZA IDROMASSAGGIO WITHOUT WHIRLPOOL	3.000
VASCA CON IDROMASSAGGIO GHOST - BATHTUB WITH GHOST WHIRLPOOL			
AWC	DIGITAL WHIRLPOOL CONTROL	V831F IDROMASSAGGIO CON IMPIANTO DIGITALE WHIRLPOOL WITH DIGITAL SYSTEM	4.900

PANNELLI PER VASCA - PANELS FOR BATHTUB

	V078F	PANNELLO FRONTALE FRONTAL PANEL	350
	V071L D/S	PANNELLO LATERALE DESTRO O SINISTRO RIGHT OR LEFT SIDE PANEL	300

DOTAZIONI VASCA BATHTUB SUPPLY	VTL	AWC
• JET IDROMASSAGGIO - WHIRLPOOL JET	—	18
• CUSCINO POGGIATESTA MORBIDO NERO - SOFT PILLOW HEADREST BLACK	1	1
• COLONNA DI SCARICO - DRAIN COLUMN	●	●
• SENSORE DI LIVELLO - LEVEL SENSOR	—	●
• MASSIMO CONTENUTO ACQUA - MAX WATER CAPACITY	350 LT.	350 LT.

LEGENDA - LEGEND

- Di serie - Of series
- Non disponibile - Not available

	OPTIONAL VASCA BATHTUB OPTIONALS	VTL	AWC
STATA	STABILIZZATORE TEMPERATURA ACQUA - WATER TEMPERATURE STABILIZER	—	600
CROLED	CROMOTERAPIA CON LED SINGOLI PERIMETRALI - CHROMOTHERAPY WITH SINGLE PERIMETER LEDS	1.500	1.500
BORDO	KIT PROFILO BORDO VASCA - BATHTUB EDGE SKIRTING KIT	50	50
8310	CUSCINO POGGIATESTA AGGIUNTIVO (NERO) - ADDITIONAL PILLOW (BLACK)	150	150

	RUBINETTERIA TAPS		CROMO CHROME
LINE	RUBINETTERIA ACQUA CALDA ACQUA FREDDA CON DEVIATORE E DOCCETTA SEMI-INCASSO HOT/COLD WATER TAPS WITH DIVERTER AND SEMI-BUILT IN HAND SHOWER		1.000
RUE	RUBINETTERIA ELETTRONICA CON DEVIATORE E DOCCETTA SEMI-INCASSO ELECTRONIC WATER TAPS WITH DIVERTER AND SEMI-BUILT IN HAND SHOWER		1.500
ERO	RIEMPIMENTO VASCA A SCOMPARSA HIDDEN FILLING		300
MLQ	MISCELATORE MONOCOMANDO QUADRATO CON DEVIATORE E DOCCETTA SQUARED SINGLE-LEVER MIXER WITH DIVERTER AND HAND-SHOWER		500
SIF	SIFONE SCARICO VASCA PLASTIC SIPHON	40	
FOR	SUPPLEMENTO PER FORATURA DIVERSA DA QUELLE PRESENTI SUL NOSTRO LISTINO SURCHARGE FOR TAPS DRILLING IF TAPS ARE NOT OUR MODELS	500	

Dream 190

190 x 110 x 66h

(GHOST®)

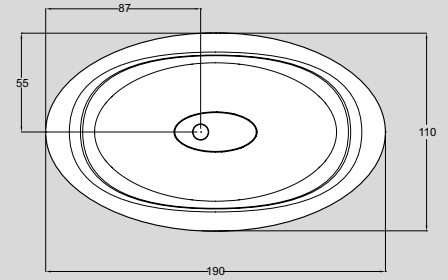

Scheda tecnica disponibile sul sito www.gruppotes.it
 Technical drawing available on www.gruppotes.it

INSTALLAZIONE / INSTALLATION

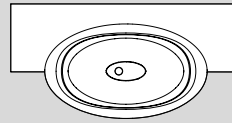

SEMI INCASSO / SEMI BUILT-IN

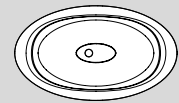

CENTROSTANZA / FREESTANDING

MODELLO MODEL	ARTICOLO ARTICLE	DESCRIZIONE DESCRIPTION		
VASCA CON TELAIO - BATHTUB WITH FRAME				
VTL	V8391	SENZA IDROMASSAGGIO WITHOUT WHIRLPOOL	5.200	
VASCA CON IDROMASSAGGIO GHOST - BATHTUB WITH GHOST WHIRLPOOL				
AWC	DIGITAL WHIRLPOOL CONTROL	V839F	IDROMASSAGGIO CON IMPIANTO DIGITALE WHIRLPOOL WITH DIGITAL SYSTEM	7.200

PANNELLI PER VASCA - PANELS FOR BATHTUB

	V839FX	PANNELLO PER INSTALLAZIONE SEMI INCASSO PANEL FOR SEMI BUILT-IN INSTALLATION	450
	V839FX 2	PANNELLI PER INSTALLAZIONE CENTRO STANZA PANELS FOR FREESTANDING INSTALLATION	900

DOTAZIONI VASCA BATHTUB SUPPLY	VTL	AWC
• JET IDROMASSAGGIO - WHIRLPOOL JET	—	18
• COLONNA DI SCARICO - DRAIN COLUMN	●	●
• SENSORE DI LIVELLO - LEVEL SENSOR	—	●
• MASSIMO CONTENUTO ACQUA - MAX WATER CAPACITY	280 LT.	280 LT.

LEGENDA - LEGEND

- **Di serie** - Of series
- **Non disponibile** - Not available

	OPTIONAL VASCA BATHTUB OPTIONALS	VTL	AWC
STATA	STABILIZZATORE TEMPERATURA ACQUA - WATER TEMPERATURE STABILIZER	—	600
CROLED	CROMOTERAPIA CON LED SINGOLI PERIMETRALI - CHROMOTHERAPY WITH SINGLE PERIMETER LEDS	1.500	1.500
SOL	SOLLEVATORE PNEUMATICO PER VASCA INCASSO - PNEUMATIC LIFT FOR BUILT-IN BATHTUB	4.500	4.500

	RUBINETTERIA TAPS		CROMO CHROME
MIX	MISCELATORE MONOCOMANDO CON DEVIATORE E DOCCETTA SINGLE-LEVER MIXER WITH DIVERTER AND HAND-SHOWER		400
RUE	RUBINETTERIA ELETTRONICA CON DEVIATORE E DOCCETTA SEMI-INCASSO ELECTRONIC WATER TAPS WITH DIVERTER AND SEMI-BUILT IN HAND SHOWER		1.500
ERO	RIEMPIMENTO VASCA A SCOMPARSA HIDDEN FILLING		300
SIF	SIFONE SCARICO VASCA PLASTIC SIPHON	40	
FOR	SUPPLEMENTO PER FORATURA DIVERSA DA QUELLE PRESENTI SUL NOSTRO LISTINO SURCHARGE FOR TAPS DRILLING IF TAPS ARE NOT OUR MODELS	500	

Dream 199

190 x 90 x 67h
(GHOST®)

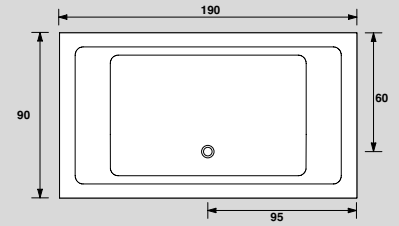

Scheda tecnica disponibile sul sito www.gruppotes.it
Technical drawing available on www.gruppotes.it

INSTALLAZIONE / INSTALLATION

DISPONIBILE ANCHE NELLE VERSIONI: 5 - 6 - 7 - 8 (RIFERIMENTO PAG 2)

AVAILABLE ALSO IN VERSIONS: 5 - 6 - 7 - 8 (REF. PAGE 2)

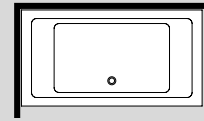

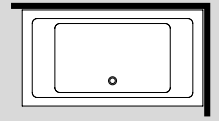

1(SX)



2(DX)

MODELLO MODEL	ARTICOLO ARTICLE	DESCRIZIONE DESCRIPTION		
VASCA CON TELAIO - BATHTUB WITH FRAME				
VTL	V8301	SENZA IDROMASSAGGIO WITHOUT WHIRLPOOL	3.000	
VASCA CON IDROMASSAGGIO GHOST - BATHTUB WITH GHOST WHIRLPOOL				
AWC	DIGITAL WHIRLPOOL CONTROL	V830F	IDROMASSAGGIO CON IMPIANTO DIGITALE WHIRLPOOL WITH DIGITAL SYSTEM	4.900

PANNELLI PER VASCA - PANELS FOR BATHTUB

	V073F	PANNELLO FRONTALE FRONTAL PANEL	350
	V073L D/S	PANNELLO LATERALE DESTRO O SINISTRO RIGHT OR LEFT SIDE PANEL	300

DOTAZIONI VASCA BATHTUB SUPPLY	VTL	AWC
• JET IDROMASSAGGIO - WHIRLPOOL JET	—	18
• CUSCINO POGGIATESTA MORBIDO NERO - SOFT PILLOW HEADREST BLACK	1	1
• COLONNA DI SCARICO - DRAIN COLUMN	●	●
• SENSORE DI LIVELLO - LEVEL SENSOR	—	●
• MASSIMO CONTENUTO ACQUA - MAX WATER CAPACITY	340 LT.	340 LT.

LEGENDA - LEGEND

- Di serie - Of series
- Non disponibile - Not available

	OPTIONAL VASCA BATHTUB OPTIONALS	VTL	AWC
STATA	STABILIZZATORE TEMPERATURA ACQUA - WATER TEMPERATURE STABILIZER	—	600
CROLED	CROMOTERAPIA CON LED SINGOLI PERIMETRALI - CHROMOTHERAPY WITH SINGLE PERIMETER LEDS	1.500	1.500
BORDO	KIT PROFILO BORDO VASCA - BATHTUB EDGE SKIRTING KIT	50	50
8310	CUSCINO POGGIATESTA AGGIUNTIVO (NERO) - ADDITIONAL PILLOW (BLACK)	150	150

	RUBINETTERIA TAPS		CROMO CHROME
LINE	RUBINETTERIA ACQUA CALDA ACQUA FREDDA CON DEVIATORE E DOCCETTA SEMI-INCASSO HOT/COLD WATER TAPS WITH DIVERTER AND SEMI-BUILT IN HAND SHOWER		1.000
RUE	RUBINETTERIA ELETTRONICA CON DEVIATORE E DOCCETTA SEMI-INCASSO ELECTRONIC WATER TAPS WITH DIVERTER AND SEMI-BUILT IN HAND SHOWER		1.500
ERO	RIEMPIMENTO VASCA A SCOMPARSA HIDDEN FILLING		300
MLQ	MISCELATORE MONOCOMANDO QUADRATO CON DEVIATORE E DOCCETTA SQUARED SINGLE-LEVER MIXER WITH DIVERTER AND HAND-SHOWER		500
SIF	SIFONE SCARICO VASCA PLASTIC SIPHON	40	
FOR	SUPPLEMENTO PER FORATURA DIVERSA DA QUELLE PRESENTI SUL NOSTRO LISTINO SURCHARGE FOR TAPS DRILLING IF TAPS ARE NOT OUR MODELS	500	

Dream 200

200 x 160 x 66h

(GHOST®)

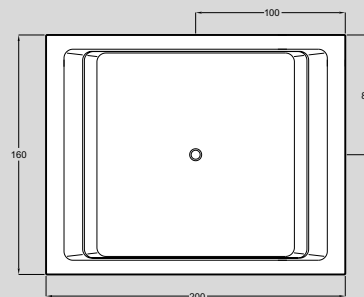

Scheda tecnica disponibile sul sito www.gruppotes.it
 Technical drawing available on www.gruppotes.it

INSTALLAZIONE / INSTALLATION

DISPONIBILE ANCHE NELLE VERSIONI: 5 - 6 - 7 - 8 (RIFERIMENTO PAG 2)
 AVAILABLE ALSO IN VERSIONS: 5 - 6 - 7 - 8 (REF. PAGE 2)

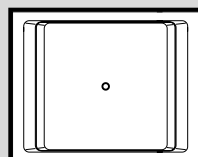

1(SX)

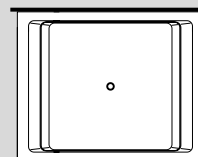

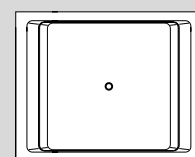

2(DX)

CENTRO STANZA
FREESTANDING

MODELLO MODEL	ARTICOLO ARTICLE	DESCRIZIONE DESCRIPTION	
VASCA CON TELAIO - BATHTUB WITH FRAME			
VTL	V8321	SENZA IDROMASSAGGIO WITHOUT WHIRLPOOL	5.200
VASCA CON IDROMASSAGGIO GHOST - BATHTUB WITH GHOST WHIRLPOOL			
AWC	DIGITAL WHIRLPOOL CONTROL	V832F IDROMASSAGGIO CON IMPIANTO DIGITALE WHIRLPOOL WITH DIGITAL SYSTEM	7.000

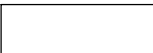
PANNELLI PER VASCA - PANELS FOR BATHTUB

	V832FX	PANNELLO FRONTALE FRONTAL PANEL	450
	V832L D/S	PANNELLO LATERALE DESTRO O SINISTRO RIGHT OR LEFT SIDE PANEL	300

DOTAZIONI VASCA BATHTUB SUPPLY	VTL	AWC
• JET IDROMASSAGGIO - WHIRLPOOL JET	—	18
• CUSCINO POGGIATESTA MORBIDO NERO - SOFT PILLOW HEADREST BLACK	2	2
• COLONNA DI SCARICO - DRAIN COLUMN	●	●
• SENSORE DI LIVELLO - LEVEL SENSOR	—	●
• MASSIMO CONTENUTO ACQUA - MAX WATER CAPACITY	780 LT.	780 LT.

LEGENDA - LEGEND

- **Di serie** - Of series
- **Non disponibile** - Not available

	OPTIONAL VASCA BATHTUB OPTIONALS	VTL	AWC
STATA	STABILIZZATORE TEMPERATURA ACQUA - WATER TEMPERATURE STABILIZER	—	600
CROLED	CROMOTERAPIA CON LED SINGOLI PERIMETRALI - CHROMOTHERAPY WITH SINGLE PERIMETER LEDS	1.500	1.500
BORDO	KIT PROFILO BORDO VASCA - BATHTUB EDGE SKIRTING KIT	50	50
SOL	SOLLEVATORE PNEUMATICO PER VASCA INCASSO - PNEUMATIC LIFT FOR BUILT-IN BATHTUB	4.500	4.500

	RUBINETTERIA TAPS		CROMO CHROME
LINE	RUBINETTERIA ACQUA CALDA ACQUA FREDDA CON DEVIATORE E DOCCETTA SEMI-INCASSO HOT/COLD WATER TAPS WITH DIVERTER AND SEMI-BUILT IN HAND SHOWER		1.000
RUE	RUBINETTERIA ELETTRONICA CON DEVIATORE E DOCCETTA SEMI-INCASSO ELECTRONIC WATER TAPS WITH DIVERTER AND SEMI-BUILT IN HAND SHOWER		1.500
ERO	RIEMPIMENTO VASCA A SCOMPARSA HIDDEN FILLING		300
MLQ	MISCELATORE MONOCOMANDO QUADRATO CON DEVIATORE E DOCCETTA SQUARED SINGLE-LEVER MIXER WITH DIVERTER AND HAND-SHOWER		500
SIF	SIFONE SCARICO VASCA PLASTIC SIPHON	40	
FOR	SUPPLEMENTO PER FORATURA DIVERSA DA QUELLE PRESENTI SUL NOSTRO LISTINO SURCHARGE FOR TAPS DRILLING IF TAPS ARE NOT OUR MODELS	500	

22 **Fusion 200** ø200 x 67h

(GHOST®)

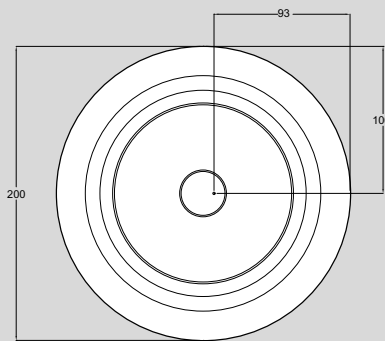
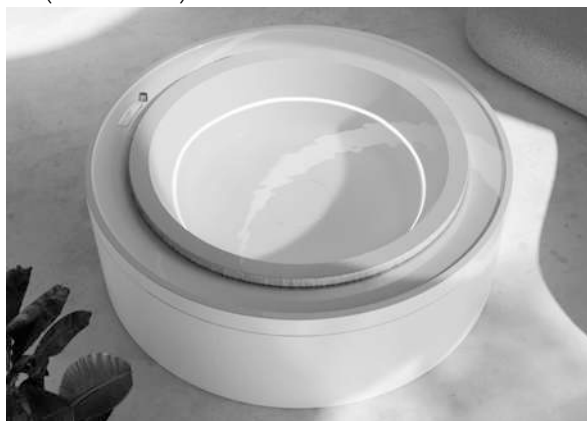

Scheda tecnica disponibile sul sito www.gruppotes.it
 Technical drawing available on www.gruppotes.it

INSTALLAZIONE / INSTALLATION

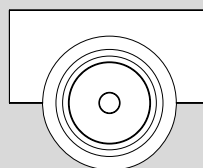

SEMI INCASSO / SEMI BUILT-IN

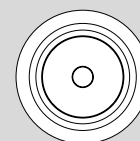

CENTROSTANZA / FREESTANDING

MODELLO MODEL	ARTICOLO ARTICLE	DESCRIZIONE DESCRIPTION	
VASCA CON IDROMASSAGGIO GHOST - BATHTUB WITH GHOST WHIRLPOOL			
SKI	SKIMMER SYSTEM	V861D	IDROMASSAGGIO CON IMPIANTO DIGITALE E SISTEMA DI RICIRCOLO AUTOMATICO WHIRLPOOL AND SYSTEM FOR WATER RECIRCULATION
			12.000

PANNELLI PER VASCA - PANELS FOR BATHTUB

	V861F	PANNELLO PER INSTALLAZIONE SEMI INCASSO PANEL FOR SEMI BUILT-IN INSTALLATION	1.150
	V861F 2	PANNELLI PER INSTALLAZIONE CENTRO STANZA PANELS FOR FREESTANDING INSTALLATION	2.300

DOTAZIONI VASCA
BATHTUB SUPPLY
SKI

• JET IDROMASSAGGIO - WHIRLPOOL JET	18
• SVUOTAMENTO VASCA ELETTRONICO / ELECTRONIC DRAINAGE	●
• SISTEMA RIEMPIMENTO VASCA A SCOMPARSA / HIDDEN FILLING	●
• RUBINETTERIA ELETTRONICA E DOCGETTA SEMI-INCASSO / ELECTRONIC WATER TAPS AND SEMI-BUILT IN HAND SHOWER	●
• SENSORE DI LIVELLO / LEVEL SENSOR	●
• SIFONE SCARICO VASCA - PLASTIC SIPHON	●
• SISTEMA RICIRCOLO ACQUA / SYSTEM FOR WATER RECIRCULATION	●

LEGENDA - LEGEND

 ● **Di serie - Of series**
OPTIONAL VASCA
BATHTUB OPTIONALS
SKI

STATA	STABILIZZATORE TEMPERATURA ACQUA - WATER TEMPERATURE STABILIZER	600
CROLED	CROMOTERAPIA CON LED SINGOLI PERIMETRALI - CHROMOTHERAPY WITH SINGLE PERIMETER LEDS	1.500
SOL1	SOLLEVATORE PNEUMATICO PER VASCA INCASSO - PNEUMATIC LIFT FOR BUILT-IN BATHTUB	4.500
FINOR	SUPPLEMENTO PER FINITURE ORO - SURCHARGE FOR GOLDEN FINISH	300

Fusion 230

230 x 180 x 67h
(GHOST®)

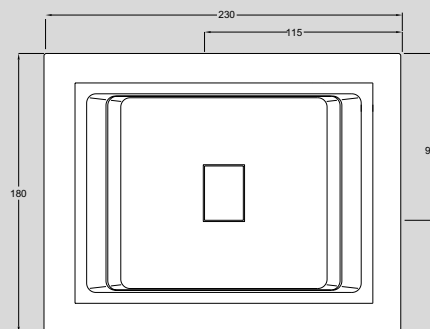

Scheda tecnica disponibile sul sito www.gruppotes.it
Technical drawing available on www.gruppotes.it

INSTALLAZIONE / INSTALLATION

DISPONIBILE ANCHE NELLE VERSIONI: 5 - 6 - 7 - 8 (RIFERIMENTO PAG 2)

AVAILABLE ALSO IN VERSIONS: 5 - 6 - 7 - 8 (REF. PAGE 2)

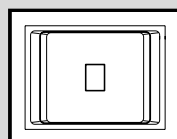

1(SX)

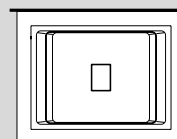

2(DX)

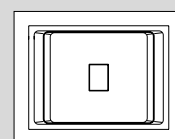

CENTRO STANZA
FREESTANDING

MODELLO MODEL	ARTICOLO ARTICLE	DESCRIZIONE DESCRIPTION	
VASCA CON IDROMASSAGGIO GHOST - BATHTUB WITH GHOST WHIRLPOOL			
SKI	SKIMMER SYSTEM	V863D	IDROMASSAGGIO, CON IMPIANTO DIGITALE E SISTEMA DI RICIRCOLO AUTOMATICO WHIRLPOOL AND SYSTEM FOR WATER RECIRCULATION
			12.400

PANNELLI PER VASCA - PANELS FOR BATHTUB

	V863F	PANNELLO FRONTALE FRONTAL PANEL	650
	V863L D/S	PANNELLO LATERALE DESTRO O SINISTRO RIGHT OR LEFT SIDE PANEL	500

DOTAZIONI VASCA
BATHTUB SUPPLY
SKI

• JET IDROMASSAGGIO - WHIRLPOOL JET	18
• SVUOTAMENTO VASCA ELETTRONICO / ELECTRONIC DRAINAGE	●
• SISTEMA RIEMPIMENTO VASCA A SCOMPARSA / HIDDEN FILLING	●
• RUBINETTERIA ELETTRONICA E DOCGETTA SEMI-INCASSO / ELECTRONIC WATER TAPS AND SEMI-BUILT IN HAND SHOWER	●
• SENSORE DI LIVELLO / LEVEL SENSOR	●
• SIFONE SCARICO VASCA - PLASTIC SIPHON	●
• SISTEMA RICIRCOLO ACQUA / SYSTEM FOR WATER RECIRCULATION	●

LEGENDA - LEGEND

 ● **Di serie - Of series**

	OPTIONAL VASCA BATHTUB OPTIONALS	SKI
STATA	STABILIZZATORE TEMPERATURA ACQUA - WATER TEMPERATURE STABILIZER	600
CROLED	CROMOTERAPIA CON LED SINGOLI PERIMETRALI - CHROMOTHERAPY WITH SINGLE PERIMETER LEDS	1.500
SOL1	SOLLEVATORE PNEUMATICO PER VASCA INCASSO - PNEUMATIC LIFT FOR BUILT-IN BATHTUB	4.500
FINOR	SUPPLEMENTO PER FINITURE ORO - SURCHARGE FOR GOLDEN FINISH	300

Fusion 231

230 x 150 x 67h

(GHOST®)

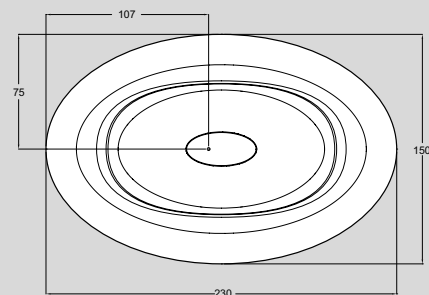

Scheda tecnica disponibile sul sito www.gruppotes.it
 Technical drawing available on www.gruppotes.it

INSTALLAZIONE / INSTALLATION

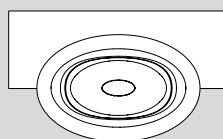

SEMI INCASSO / SEMI BUILT-IN

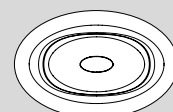

CENTROSTANZA / FREESTANDING

MODELLO MODEL	ARTICOLO ARTICLE	DESCRIZIONE DESCRIPTION	
VASCA CON IDROMASSAGGIO GHOST - BATHTUB WITH GHOST WHIRLPOOL			
SKI	SKIMMER SYSTEM	V864D	IDROMASSAGGIO CON IMPIANTO DIGITALE E SISTEMA DI RICIRCOLO AUTOMATICO WHIRLPOOL AND SYSTEM FOR WATER RECIRCULATION
			12.000

PANNELLI PER VASCA - PANELS FOR BATHTUB

	V864F	PANNELLO PER INSTALLAZIONE SEMI INCASSO PANEL FOR SEMI BUILT-IN INSTALLATION	1.150
	V864F 2	PANNELLI PER INSTALLAZIONE CENTRO STANZA PANELS FOR FREESTANDING INSTALLATION	2.300

DOTAZIONI VASCA
BATHTUB SUPPLY
SKI

• JET IDROMASSAGGIO - WHIRLPOOL JET	18
• SVUOTAMENTO VASCA ELETTRONICO / ELECTRONIC DRAINAGE	●
• SISTEMA RIEMPIMENTO VASCA A SCOMPARSA / HIDDEN FILLING	●
• RUBINETTERIA ELETTRONICA E DOCGETTA SEMI-INCASSO / ELECTRONIC WATER TAPS AND SEMI-BUILT IN HAND SHOWER	●
• SENSORE DI LIVELLO / LEVEL SENSOR	●
• SIFONE SCARICO VASCA - PLASTIC SIPHON	●
• SISTEMA RICIRCOLO ACQUA / SYSTEM FOR WATER RECIRCULATION	●

LEGENDA - LEGEND

 ● **Di serie - Of series**
OPTIONAL VASCA
BATHTUB OPTIONALS
SKI

STATA	STABILIZZATORE TEMPERATURA ACQUA - WATER TEMPERATURE STABILIZER	600
CROLED	CROMOTERAPIA CON LED SINGOLI PERIMETRALI - CHROMOTHERAPY WITH SINGLE PERIMETER LEDS	1.500
SOL1	SOLLEVATORE PNEUMATICO PER VASCA INCASSO - PNEUMATIC LIFT FOR BUILT-IN BATHTUB	4.500
FINOR	SUPPLEMENTO PER FINITURE ORO - SURCHARGE FOR GOLDEN FINISH	300

(GHOST®)

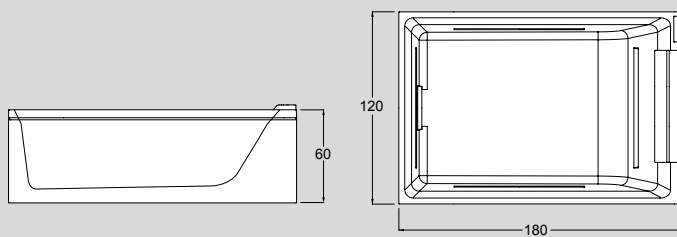

Scheda tecnica disponibile sul sito www.gruppotes.it
 Technical drawing available on www.gruppotes.it

INSTALLAZIONE / INSTALLATION

**DISPONIBILE ANCHE NELLE VERSIONI:
 3 - 4 - 5 - 6 - 7 (RIFERIMENTO PAG 2)**
 AVAILABLE ALSO IN VERSIONS:
 3 - 4 - 5 - 6 - 7 (REF. PAGE 2)

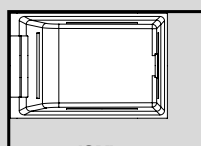

1(SX)

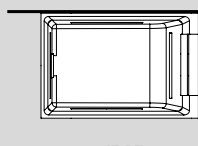

2(DX)

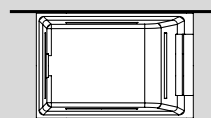

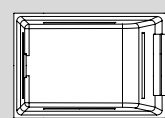

**A PARETE
 TO WALL**



**CENTRO STANZA
 FREESTANDING**

MODELLO MODEL	ARTICOLO ARTICLE	DESCRIZIONE DESCRIPTION	
VASCA CON IDROMASSAGGIO GHOST - BATHTUB WITH GHOST WHIRLPOOL			
AWD DIGITAL WHIRLPOOL AND DRAIN CONTROL	V408R	IDROMASSAGGIO CON IMPIANTO DIGITALE WHIRLPOOL WITH DIGITAL SYSTEM	6.250
AAD DIGITAL WHIRLPOOL/ AIRPOOL AND DRAIN CONTROL	V408S	IDROMASSAGGIO E AIRPOOL CON IMPIANTO DIGITALE WHIRLPOOL AND AIRPOOL WITH DIGITAL SYSTEM	8.500

PANNELLI PER VASCA - PANELS FOR BATHTUB

	V408F	PANNELLO FRONTALE FRONTAL PANEL	450
	V408L D/S	PANNELLO LATERALE DESTRO O SINISTRO RIGHT OR LEFT SIDE PANEL	300

DOTAZIONI VASCA BATHTUB SUPPLY	AWD	AAD
• JET IDROMASSAGGIO - WHIRLPOOL JET	18	18
• JET AIRPOOL - AIRPOOL JET	—	24
• CUSCINO POGGIATESTA MORBIDO NERO - SOFT PILLOW HEADREST BLACK	1	1
• SVUOTAMENTO VASCA ELETTRONICO - ELECTRONIC DRAINAGE	●	●
• SENSORE DI LIVELLO - LEVEL SENSOR	●	●
• MASSIMO CONTENUTO ACQUA - MAX WATER CAPACITY	560 LT.	560 LT.

LEGENDA - LEGEND

- Di serie - Of series
- Non disponibile - Not available

	OPTIONAL VASCA BATHTUB OPTIONALS	AWD	AAD
STATA	STABILIZZATORE TEMPERATURA ACQUA - WATER TEMPERATURE STABILIZER	600	600
CROLED	CROMOTERAPIA CON LED SINGOLI PERIMETRALI - CHROMOTHERAPY WITH SINGLE PERIMETER LEDS	1.500	1.500
BORDO	KIT PROFILO BORDO VASCA - BATHTUB EDGE SKIRTING KIT	50	50
SOL	SOLLEVATORE PNEUMATICO PER VASCA INCASSO - PNEUMATIC LIFT FOR BUILT-IN BATHTUB	4.500	4.500

	RUBINETTERIA TAPS		CROMO CHROME
RUE	RUBINETTERIA ELETTRONICA CON DEVIATORE E DOCCETTA SEMI-INCASSO ELECTRONIC WATER TAPS WITH DIVERTER AND SEMI-BUILT IN HAND SHOWER		1.500
ERO	RIEMPIMENTO VASCA A SCOMPARSA HIDDEN FILLING		300
MLQ	MISCELATORE MONOCOMANDO QUADRATO CON DEVIATORE E DOCCETTA SQUARED SINGLE-LEVER MIXER WITH DIVERTER AND HAND-SHOWER		500
SIF	SIFONE SCARICO VASCA PLASTIC SIPHON	40	
FOR	SUPPLEMENTO PER FORATURA DIVERSA DA QUELLE PRESENTI SUL NOSTRO LISTINO SURCHARGE FOR TAPS DRILLING IF TAPS ARE NOT OUR MODELS	500	

Soul 150 195 x 150 x 60h

(GHOST®)

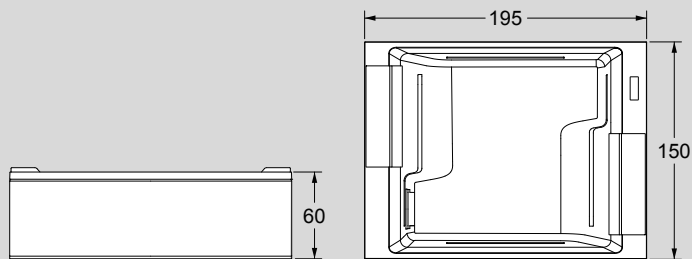

Scheda tecnica disponibile sul sito www.gruppoptres.it
 Technical drawing available on www.gruppoptres.it

INSTALLAZIONE / INSTALLATION

DISPONIBILE ANCHE NELLE VERSIONI:
 3 - 4 - 5 - 6 - 7 (RIFERIMENTO PAG 2)
 AVAILABLE ALSO IN VERSIONS:
 3 - 4 - 5 - 6 - 7 (REF. PAGE 2)

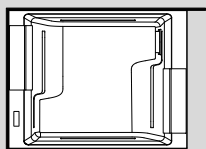

1(SX)

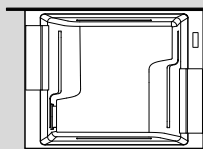

2(DX)

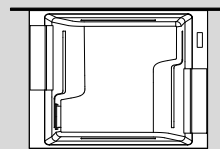

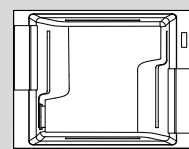

A PARETE
TO WALL



CENTRO STANZA
FREESTANDING

MODELLO MODEL	ARTICOLO ARTICLE	DESCRIZIONE DESCRIPTION	
VASCA CON IDROMASSAGGIO GHOST - BATHTUB WITH GHOST WHIRLPOOL			
AWD DIGITAL WHIRLPOOL AND DRAIN CONTROL	V409R	IDROMASSAGGIO CON IMPIANTO DIGITALE WHIRLPOOL WITH DIGITAL SYSTEM	7.500
AAD DIGITAL WHIRLPOOL/ AIRPOOL AND DRAIN CONTROL	V409S	IDROMASSAGGIO E AIRPOOL CON IMPIANTO DIGITALE WHIRLPOOL AND AIRPOOL WITH DIGITAL SYSTEM	10.100

PANNELLI PER VASCA - PANELS FOR BATHTUB

	V409F	PANNELLO FRONTALE FRONTAL PANEL	450
	V409L D/S	PANNELLO LATERALE DESTRO O SINISTRO RIGHT OR LEFT SIDE PANEL	300

DOTAZIONI VASCA BATHTUB SUPPLY	AWD	AAD
• JET IDROMASSAGGIO - WHIRLPOOL JET	18	18
• JET AIRPOOL - AIRPOOL JET	—	24
• CUSCINO POGGIATESTA MORBIDO NERO - SOFT PILLOW HEADREST BLACK	2	2
• SVUOTAMENTO VASCA ELETTRONICO - ELECTRONIC DRAINAGE	●	●
• SENSORE DI LIVELLO - LEVEL SENSOR	●	●
• MASSIMO CONTENUTO ACQUA - MAX WATER CAPACITY	580 LT.	580 LT.

LEGENDA - LEGEND

- **Di serie** - Of series
- **Non disponibile** - Not available

	OPTIONAL VASCA BATHTUB OPTIONALS	AWD	AAD
STATA	STABILIZZATORE TEMPERATURA ACQUA - WATER TEMPERATURE STABILIZER	600	600
CROLED	CROMOTERAPIA CON LED SINGOLI PERIMETRALI - CHROMOTHERAPY WITH SINGLE PERIMETER LEDS	1.500	1.500
BORDO	KIT PROFILO BORDO VASCA - BATHTUB EDGE SKIRTING KIT	50	50
SOL	SOLLEVATORE PNEUMATICO PER VASCA INCASSO - PNEUMATIC LIFT FOR BUILT-IN BATHTUB	4.500	4.500

	RUBINETTERIA TAPS		CROMO CHROME
RUE	RUBINETTERIA ELETTRONICA CON DEVIATORE E DOCCETTA SEMI-INCASSO ELECTRONIC WATER TAPS WITH DIVERTER AND SEMI-BUILT IN HAND SHOWER		1.500
ERO	RIEMPIMENTO VASCA A SCOMPARSA HIDDEN FILLING		300
MLQ	MISCELATORE MONOCOMANDO QUADRATO CON DEVIATORE E DOCCETTA SQUARED SINGLE-LEVER MIXER WITH DIVERTER AND HAND-SHOWER		500
SIF	SIFONE SCARICO VASCA PLASTIC SIPHON	40	
FOR	SUPPLEMENTO PER FORATURA DIVERSA DA QUELLE PRESENTI SUL NOSTRO LISTINO SURCHARGE FOR TAPS DRILLING IF TAPS ARE NOT OUR MODELS	500	

Vasche Freestanding

Freestanding Bathtubs

ALMA	34
BALI	36
BRIO	38
CALIDA	40
CAMELIA	42
CAREZZA 170	44
CAREZZA 180	46
CLIVIA 160	48
CLIVIA 170	50
CORA	52
CROSS	54
EPOCA	56
GRAND SOLEIL	58
ILIA	60
INKA 150	62
INKA 180	64
NIÑA	66
VERA	68
VIVA	70

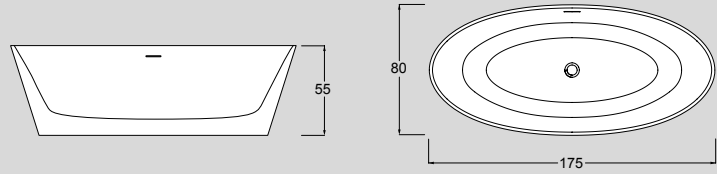

Scheda tecnica disponibile sul sito www.gruppotes.it
 Technical drawing available on www.gruppotes.it

INSTALLAZIONE / INSTALLATION

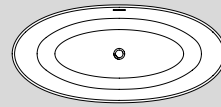

CENTRO STANZA - FREESTANDING

MODELLO MODEL	ARTICOLO ARTICLE	DESCRIZIONE DESCRIPTION	
	V015BL	VASCA IN SOLID SURFACE BIANCO LUCIDO BATHTUB IN SOLID SURFACE GLOSSY WHITE	3.350
	V015B0	VASCA IN SOLID SURFACE BIANCO OPACO BATHTUB IN SOLID SURFACE MATT WHITE	3.450

DOTAZIONI VASCA
BATHTUB SUPPLY

- **PILETTA DI SCARICO - DRAIN-HOLE**

●

- **MASSIMO CONTENUTO ACQUA - MAX WATER CAPACITY**

255 LT.

LEGENDA - LEGEND● **Di serie - Standard**

CODICE CODE	SUPPLEMENTO PER TABELLA COLORI (SOLO ESTERNO) COLOUR CHART SUPPLEMENT (EXTERNAL ONLY)	
IB	INK BLACK	950
NB	NIGHT BLUE	950
PG	PEARL GREY	950
LS	LONDON SMOKE	950
GB	GREY BROWN	950
RR	RUBY RED	950
MC	MILK&COFFEE	950
DS	DESERT SAND	950
OW	OYSTER WHITE	950
MG	MINT GREEN	950
GT	GREEN TEA	950
BS	BLUE SKY	950
FL	FLAMINGO	950
SR	SHELL ROSE	950

Bali

160 x 85 x 62h

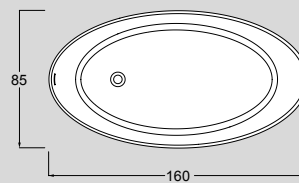
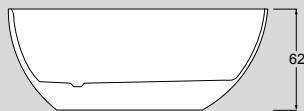

Scheda tecnica disponibile sul sito www.gruppotes.it
 Technical drawing available on www.gruppotes.it

INSTALLAZIONE / INSTALLATION

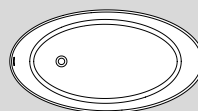

CENTRO STANZA - FREESTANDING

MODELLO MODEL	ARTICOLO ARTICLE	DESCRIZIONE DESCRIPTION	
	V026BL	VASCA IN SOLID SURFACE BIANCO LUCIDO BATHTUB IN SOLID SURFACE GLOSSY WHITE	3.250
	V026B0	VASCA IN SOLID SURFACE BIANCO OPACO BATHTUB IN SOLID SURFACE MATT WHITE	3.350

DOTAZIONI VASCA
BATHTUB SUPPLY

• PILETTA DI SCARICO - DRAIN-HOLE

●

• MASSIMO CONTENUTO ACQUA - MAX WATER CAPACITY

330 LT.

LEGENDA - LEGEND

● Di serie - Standard

CODICE CODE		SUPPLEMENTO PER TABELLA COLORI (SOLO ESTERNO) COLOUR CHART SUPPLEMENT (EXTERNAL ONLY)	
IB	INK BLACK		950
NB	NIGHT BLUE		950
PG	PEARL GREY		950
LS	LONDON SMOKE		950
GB	GREY BROWN		950
RR	RUBY RED		950
MC	MILK&COFFEE		950
DS	DESERT SAND		950
OW	OYSTER WHITE		950
MG	MINT GREEN		950
GT	GREEN TEA		950
BS	BLUE SKY		950
FL	FLAMINGO		950
SR	SHELL ROSE		950

Brio 170 x 72 x 56h

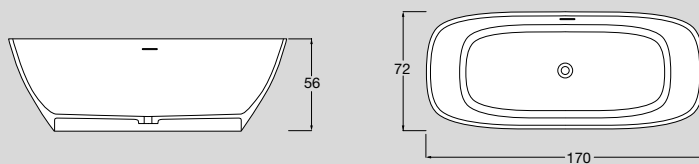

Scheda tecnica disponibile sul sito www.gruppotes.it
 Technical drawing available on www.gruppotes.it

INSTALLAZIONE / INSTALLATION

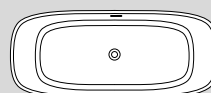

CENTRO STANZA - FREESTANDING

MODELLO MODEL	ARTICOLO ARTICLE	DESCRIZIONE DESCRIPTION	
	V297BL	VASCA IN SOLID SURFACE BIANCO LUCIDO BATHTUB IN SOLID SURFACE GLOSSY WHITE	3.050
	V297B0	VASCA IN SOLID SURFACE BIANCO OPACO BATHTUB IN SOLID SURFACE MATT WHITE	3.150

DOTAZIONI VASCA
BATHTUB SUPPLY

• PILETTA DI SCARICO - DRAIN-HOLE

●

• MASSIMO CONTENUTO ACQUA - MAX WATER CAPACITY

310 LT.

LEGENDA - LEGEND

● Di serie - Standard

CODICE CODE		SUPPLEMENTO PER TABELLA COLORI (SOLO ESTERNO) COLOUR CHART SUPPLEMENT (EXTERNAL ONLY)	
IB	INK BLACK		950
NB	NIGHT BLUE		950
PG	PEARL GREY		950
LS	LONDON SMOKE		950
GB	GREY BROWN		950
RR	RUBY RED		950
MC	MILK&COFFEE		950
DS	DESERT SAND		950
OW	OYSTER WHITE		950
MG	MINT GREEN		950
GT	GREEN TEA		950
BS	BLUE SKY		950
FL	FLAMINGO		950
SR	SHELL ROSE		950

Calida 155 x 80 x 58h

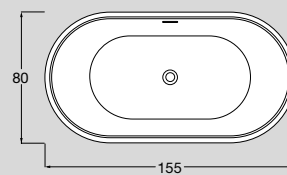
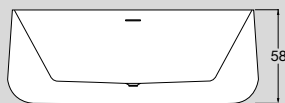

Scheda tecnica disponibile sul sito www.gruppotes.it
 Technical drawing available on www.gruppotes.it

INSTALLAZIONE / INSTALLATION

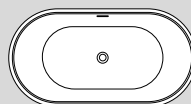

CENTRO STANZA - FREESTANDING

MODELLO MODEL	ARTICOLO ARTICLE	DESCRIZIONE DESCRIPTION	
	V035BL	VASCA IN ACRILICO BIANCO LUCIDO BATHTUB ACRYLIC GLOSSY WHITE	1.850
	V035BO	VASCA IN ACRILICO BIANCO OPACO BATHTUB ACRYLIC MATT WHITE	2.100

DOTAZIONI VASCA BATHTUB SUPPLY

• **PILETTA DI SCARICO** - DRAIN-HOLE

●

• **MASSIMO CONTENUTO ACQUA** - MAX WATER CAPACITY

300 LT.

LEGENDA - LEGEND

● **Di serie** - Standard

CODICE CODE		SUPPLEMENTO PER TABELLA COLORI (SOLO ESTERNO) COLOUR CHART SUPPLEMENT (EXTERNAL ONLY)	
IB	INK BLACK		950
NB	NIGHT BLUE		950
PG	PEARL GREY		950
LS	LONDON SMOKE		950
GB	GREY BROWN		950
RR	RUBY RED		950
MC	MILK&COFFEE		950
DS	DESERT SAND		950
OW	OYSTER WHITE		950
MG	MINT GREEN		950
GT	GREEN TEA		950
BS	BLUE SKY		950
FL	FLAMINGO		950
SR	SHELL ROSE		950

Camelia 180 x 85 x 50h

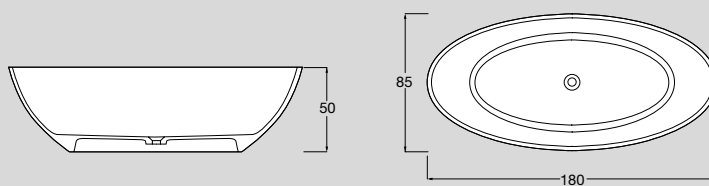

Scheda tecnica disponibile sul sito www.gruppotes.it
 Technical drawing available on www.gruppotes.it

INSTALLAZIONE / INSTALLATION

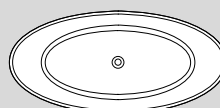

CENTRO STANZA - FREESTANDING

MODELLO MODEL	ARTICOLO ARTICLE	DESCRIZIONE DESCRIPTION	
	V047FU	VASCA IN RESINA TRASPARENTE FUMÉ BATHTUB IN SMOKEY TRANSPARENT RESIN	4.600

DOTAZIONI VASCA
BATHTUB SUPPLY

• PILETTA DI SCARICO - DRAIN-HOLE	●
• MASSIMO CONTENUTO ACQUA - MAX WATER CAPACITY	330 LT.

LEGENDA - LEGEND

- **Di serie** - Standard

Carezza 170

170 x 80 x 52h

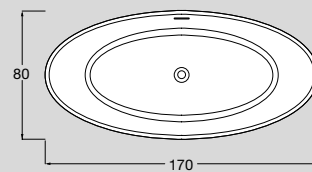
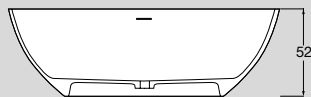

Scheda tecnica disponibile sul sito www.gruppotes.it
 Technical drawing available on www.gruppotes.it

INSTALLAZIONE / INSTALLATION

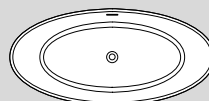

CENTRO STANZA - FREESTANDING

MODELLO MODEL	ARTICOLO ARTICLE	DESCRIZIONE DESCRIPTION	
	V307BL	VASCA IN SOLID SURFACE BIANCO LUCIDO BATHTUB IN SOLID SURFACE GLOSSY WHITE	2.900
	V307B0	VASCA IN SOLID SURFACE BIANCO OPACO BATHTUB IN SOLID SURFACE MATT WHITE	3.000

DOTAZIONI VASCA BATHTUB SUPPLY

• PILETTA DI SCARICO - DRAIN-HOLE

●

• MASSIMO CONTENUTO ACQUA - MAX WATER CAPACITY

300 LT.

LEGENDA - LEGEND

● Di serie - Standard

CODICE CODE	SUPPLEMENTO PER TABELLA COLORI (SOLO ESTERNO) COLOUR CHART SUPPLEMENT (EXTERNAL ONLY)	
IB	INK BLACK	950
NB	NIGHT BLUE	950
PG	PEARL GREY	950
LS	LONDON SMOKE	950
GB	GREY BROWN	950
RR	RUBY RED	950
MC	MILK&COFFEE	950
DS	DESERT SAND	950
OW	OYSTER WHITE	950
MG	MINT GREEN	950
GT	GREEN TEA	950
BS	BLUE SKY	950
FL	FLAMINGO	950
SR	SHELL ROSE	950

Carezza 180

180 x 85 x 52h

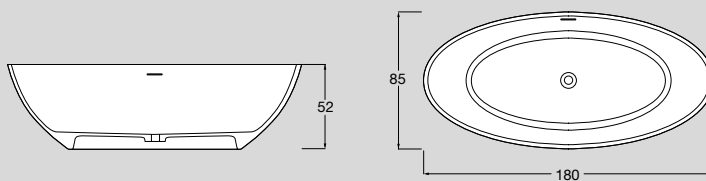

Scheda tecnica disponibile sul sito www.gruppotes.it
 Technical drawing available on www.gruppotes.it

INSTALLAZIONE / INSTALLATION

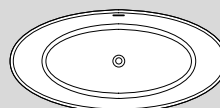

CENTRO STANZA - FREESTANDING

MODELLO MODEL	ARTICOLO ARTICLE	DESCRIZIONE DESCRIPTION	
	V308BL	VASCA IN SOLID SURFACE BIANCO LUCIDO BATHTUB IN SOLID SURFACE GLOSSY WHITE	3.350
	V308BO	VASCA IN SOLID SURFACE BIANCO OPACO BATHTUB IN SOLID SURFACE MATT WHITE	3.450

DOTAZIONI VASCA BATHTUB SUPPLY

• PILETTA DI SCARICO - DRAIN-HOLE

●

• MASSIMO CONTENUTO ACQUA - MAX WATER CAPACITY

310 LT.

LEGENDA - LEGEND

● Di serie - Standard

CODICE CODE	SUPPLEMENTO PER TABELLA COLORI (SOLO ESTERNO) COLOUR CHART SUPPLEMENT (EXTERNAL ONLY)	
IB	INK BLACK	950
NB	NIGHT BLUE	950
PG	PEARL GREY	950
LS	LONDON SMOKE	950
GB	GREY BROWN	950
RR	RUBY RED	950
MC	MILK&COFFEE	950
DS	DESERT SAND	950
OW	OYSTER WHITE	950
MG	MINT GREEN	950
GT	GREEN TEA	950
BS	BLUE SKY	950
FL	FLAMINGO	950
SR	SHELL ROSE	950

Clivia 160

160 x 75 x 57h

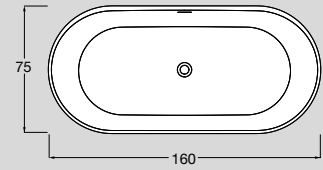
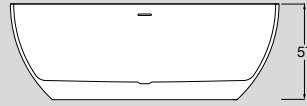

Scheda tecnica disponibile sul sito www.gruppotes.it
 Technical drawing available on www.gruppotes.it

INSTALLAZIONE / INSTALLATION

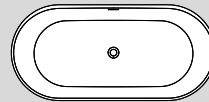

CENTRO STANZA - FREESTANDING

MODELLO MODEL	ARTICOLO ARTICLE	DESCRIZIONE DESCRIPTION	
	V446BL	VASCA IN SOLID SURFACE BIANCO LUCIDO BATHTUB IN SOLID SURFACE GLOSSY WHITE	3.250
	V446BO	VASCA IN SOLID SURFACE BIANCO OPACO BATHTUB IN SOLID SURFACE MATT WHITE	3.350

DOTAZIONI VASCA
BATHTUB SUPPLY

• PILETTA DI SCARICO - DRAIN-HOLE

●

• MASSIMO CONTENUTO ACQUA - MAX WATER CAPACITY

290 LT.

LEGENDA - LEGEND

● Di serie - Standard

CODICE CODE		SUPPLEMENTO PER TABELLA COLORI (SOLO ESTERNO) COLOUR CHART SUPPLEMENT (EXTERNAL ONLY)	
IB	INK BLACK		950
NB	NIGHT BLUE		950
PG	PEARL GREY		950
LS	LONDON SMOKE		950
GB	GREY BROWN		950
RR	RUBY RED		950
MC	MILK&COFFEE		950
DS	DESERT SAND		950
OW	OYSTER WHITE		950
MG	MINT GREEN		950
GT	GREEN TEA		950
BS	BLUE SKY		950
FL	FLAMINGO		950
SR	SHELL ROSE		950

Clivia 170

170 x 80 x 60h

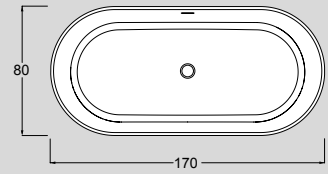
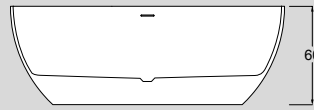

Scheda tecnica disponibile sul sito www.gruppotes.it
 Technical drawing available on www.gruppotes.it

INSTALLAZIONE / INSTALLATION

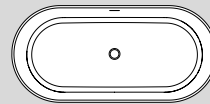

CENTRO STANZA - FREESTANDING

MODELLO MODEL	ARTICOLO ARTICLE	DESCRIZIONE DESCRIPTION	
	V447BL	VASCA IN SOLID SURFACE BIANCO LUCIDO BATHTUB IN SOLID SURFACE GLOSSY WHITE	3.350
	V447B0	VASCA IN SOLID SURFACE BIANCO OPACO BATHTUB IN SOLID SURFACE MATT WHITE	3.450

DOTAZIONI VASCA BATHTUB SUPPLY

• PILETTA DI SCARICO - DRAIN-HOLE

●

• MASSIMO CONTENUTO ACQUA - MAX WATER CAPACITY

355 LT.

LEGENDA - LEGEND

● Di serie - Standard

CODICE CODE	SUPPLEMENTO PER TABELLA COLORI (SOLO ESTERNO) COLOUR CHART SUPPLEMENT (EXTERNAL ONLY)	
IB	INK BLACK	950
NB	NIGHT BLUE	950
PG	PEARL GREY	950
LS	LONDON SMOKE	950
GB	GREY BROWN	950
RR	RUBY RED	950
MC	MILK&COFFEE	950
DS	DESERT SAND	950
OW	OYSTER WHITE	950
MG	MINT GREEN	950
GT	GREEN TEA	950
BS	BLUE SKY	950
FL	FLAMINGO	950
SR	SHELL ROSE	950

Cora 170 x 75 x 60h

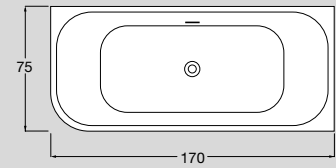
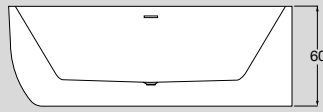

Scheda tecnica disponibile sul sito www.gruppotes.it
 Technical drawing available on www.gruppotes.it

INSTALLAZIONE / INSTALLATION

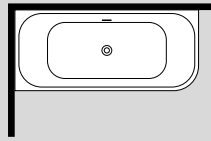

(SX)

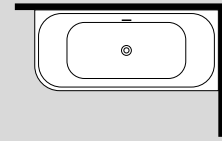

(DX)

MODELLO MODEL	ARTICOLO ARTICLE	DESCRIZIONE DESCRIPTION	
	V057BL	VASCA IN ACRILICO BIANCO LUCIDO BATHTUB ACRYLIC GLOSSY WHITE	1.800
	V057BO	VASCA IN ACRILICO BIANCO OPACO BATHTUB ACRYLIC MATT WHITE	2.100

DOTAZIONI VASCA BATHTUB SUPPLY

• **PILETTA DI SCARICO** - DRAIN-HOLE

●

• **MASSIMO CONTENUTO ACQUA** - MAX WATER CAPACITY

280 LT.

LEGENDA - LEGEND

● **Di serie** - Standard

CODICE CODE		SUPPLEMENTO PER TABELLA COLORI (SOLO ESTERNO) COLOUR CHART SUPPLEMENT (EXTERNAL ONLY)	
IB	INK BLACK		950
NB	NIGHT BLUE		950
PG	PEARL GREY		950
LS	LONDON SMOKE		950
GB	GREY BROWN		950
RR	RUBY RED		950
MC	MILK&COFFEE		950
DS	DESERT SAND		950
OW	OYSTER WHITE		950
MG	MINT GREEN		950
GT	GREEN TEA		950
BS	BLUE SKY		950
FL	FLAMINGO		950
SR	SHELL ROSE		950

Cross 160 x 73 x 60h

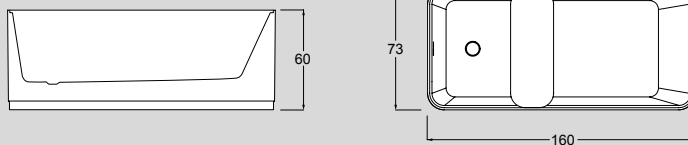

Scheda tecnica disponibile sul sito www.gruppotes.it
 Technical drawing available on www.gruppotes.it

INSTALLAZIONE / INSTALLATION

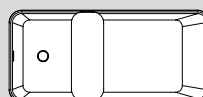

CENTRO STANZA - FREESTANDING

MODELLO MODEL	ARTICOLO ARTICLE	DESCRIZIONE DESCRIPTION	
	V396BL	VASCA IN SOLID SURFACE BIANCO LUCIDO BATHTUB IN SOLID SURFACE GLOSSY WHITE	3.250
	V396B0	VASCA IN SOLID SURFACE BIANCO OPACO BATHTUB IN SOLID SURFACE MATT WHITE	3.350

DOTAZIONI VASCA
BATHTUB SUPPLY

• PILETTA DI SCARICO - DRAIN-HOLE

●

• MASSIMO CONTENUTO ACQUA - MAX WATER CAPACITY

320 LT.

LEGENDA - LEGEND

● Di serie - Standard

OPTIONAL VASCA BATHTUB OPTIONALS		
V39POBL	PIANO PORTAOGGETTI IN SOLID SURFACE BIANCO LUCIDO - SHELF FOR OBJECT IN SOLID SURFACE GLOSSY WHITE	350
V39POBO	PIANO PORTAOGGETTI IN SOLID SURFACE BIANCO OPACO - SHELF FOR OBJECT IN SOLID SURFACE MATT WHITE	350

CODICE CODE			SUPPLEMENTO PER TABELLA COLORI (SOLO ESTERNO) COLOUR CHART SUPPLEMENT (EXTERNAL ONLY)		
IB	INK BLACK	950			
NB	NIGHT BLUE	950			
PG	PEARL GREY	950			
LS	LONDON SMOKE	950			
GB	GREY BROWN	950			
RR	RUBY RED	950			
MC	MILK&COFFEE	950			
DS	DESERT SAND	950			
OW	OYSTER WHITE	950			
MG	MINT GREEN	950			
GT	GREEN TEA	950			
BS	BLUE SKY	950			
FL	FLAMINGO	950			
SR	SHELL ROSE	950			

Epoca 170 x 80 x 72h

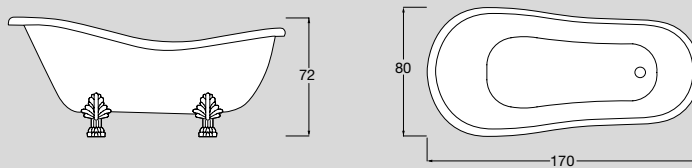

Scheda tecnica disponibile sul sito www.gruppotes.it
 Technical drawing available on www.gruppotes.it

INSTALLAZIONE / INSTALLATION

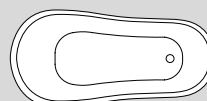

CENTRO STANZA - FREESTANDING

MODELLO MODEL	ARTICOLO ARTICLE	DESCRIZIONE DESCRIPTION	CROMO CHROME	BIANCO WHITE	ORO GOLD	BRONZO BRONZE
GUSCIO - BATHTUB SHELL						
	V5071	SENZA IDROMASSAGGIO WITHOUT WHIRLPOOL	2.100	2.100	2.300	2.500

DOTAZIONI VASCA BATHTUB SUPPLY

- COLONNA DI SCARICO CON SIFONE - DRAIN COLUMN WITH SIPHON
- PIEDI - FEET
- MASSIMO CONTENUTO ACQUA - MAX WATER CAPACITY

●

●

165 LT.

LEGENDA - LEGEND

- Di serie - Standard

CODICE CODE	SUPPLEMENTO PER TABELLA COLORI (SOLO ESTERNO) COLOUR CHART SUPPLEMENT (EXTERNAL ONLY)	
IB	INK BLACK	950
NB	NIGHT BLUE	950
PG	PEARL GREY	950
LS	LONDON SMOKE	950
GB	GREY BROWN	950
RR	RUBY RED	950
MC	MILK&COFFEE	950
DS	DESERT SAND	950
OW	OYSTER WHITE	950
MG	MINT GREEN	950
GT	GREEN TEA	950
BS	BLUE SKY	950
FL	FLAMINGO	950
SR	SHELL ROSE	950

Grand Soleil 185 x 85 x 75h

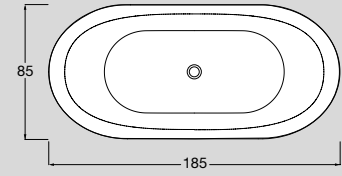
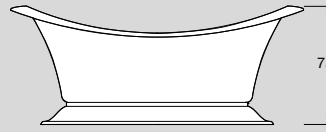

Scheda tecnica disponibile sul sito www.gruppotes.it
 Technical drawing available on www.gruppotes.it

INSTALLAZIONE / INSTALLATION

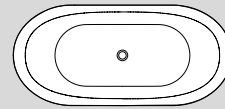

CENTRO STANZA - FREESTANDING

MODELLO MODEL	ARTICOLO ARTICLE	DESCRIZIONE DESCRIPTION	CROMO CHROME	BIANCO WHITE	ORO GOLD	BRONZO BRONZE
GUSCIO - BATHTUB SHELL						
	V1881	SENZA IDROMASSAGGIO WITHOUT WHIRLPOOL	3.000	3.000	3.150	3.250

DOTAZIONI VASCA
BATHTUB SUPPLY

• SCARICO A PULSANTE - BUTTON DRAIN	●
• BASAMENTO IN STILE CLASSICO IN UN UNICO PEZZO - CLASSIC-STYLE BASE, SINGLE BLOCK	●
• MASSIMO CONTENUTO ACQUA - MAX WATER CAPACITY	245 LT.

LEGENDA - LEGEND

- **Di serie** - Standard

CODICE CODE	SUPPLEMENTO PER TABELLA COLORI (SOLO ESTERNO) COLOUR CHART SUPPLEMENT (EXTERNAL ONLY)	
IB	INK BLACK	950
NB	NIGHT BLUE	950
PG	PEARL GREY	950
LS	LONDON SMOKE	950
GB	GREY BROWN	950
RR	RUBY RED	950
MC	MILK&COFFEE	950
DS	DESERT SAND	950
OW	OYSTER WHITE	950
MG	MINT GREEN	950
GT	GREEN TEA	950
BS	BLUE SKY	950
FL	FLAMINGO	950
SR	SHELL ROSE	950

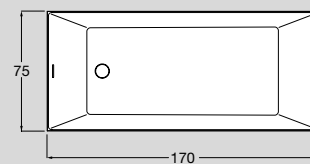
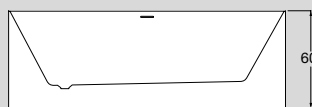

Scheda tecnica disponibile sul sito www.gruppotes.it
 Technical drawing available on www.gruppotes.it

INSTALLAZIONE / INSTALLATION

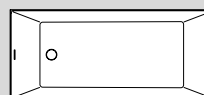

CENTRO STANZA - FREESTANDING

MODELLO MODEL	ARTICOLO ARTICLE	DESCRIZIONE DESCRIPTION	
	V375BL	VASCA IN ACRILICO BIANCO LUCIDO BATHTUB ACRYLIC GLOSSY WHITE	1.900
	V375BO	VASCA IN ACRILICO BIANCO OPACO BATHTUB ACRYLIC MATT WHITE	2.200

DOTAZIONI VASCA BATHTUB SUPPLY

● **PILETTA DI SCARICO** - DRAIN-HOLE

●

● **MASSIMO CONTENUTO ACQUA** - MAX WATER CAPACITY

348 LT.

LEGENDA - LEGEND

● **Di serie** - Standard

CODICE CODE		SUPPLEMENTO PER TABELLA COLORI (SOLO ESTERNO) COLOUR CHART SUPPLEMENT (EXTERNAL ONLY)	
IB	INK BLACK		950
NB	NIGHT BLUE		950
PG	PEARL GREY		950
LS	LONDON SMOKE		950
GB	GREY BROWN		950
RR	RUBY RED		950
MC	MILK&COFFEE		950
DS	DESERT SAND		950
OW	OYSTER WHITE		950
MG	MINT GREEN		950
GT	GREEN TEA		950
BS	BLUE SKY		950
FL	FLAMINGO		950
SR	SHELL ROSE		950

Inka 150

150 x 70 x 60h

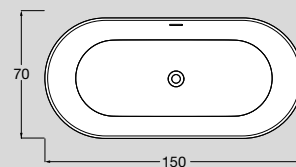
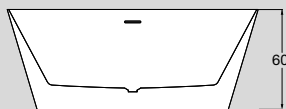

Scheda tecnica disponibile sul sito www.gruppotes.it
 Technical drawing available on www.gruppotes.it

INSTALLAZIONE / INSTALLATION

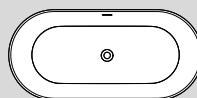

CENTRO STANZA - FREESTANDING

MODELLO MODEL	ARTICOLO ARTICLE	DESCRIZIONE DESCRIPTION	
	V385BL	VASCA IN ACRILICO BIANCO LUCIDO BATHTUB ACRYLIC GLOSSY WHITE	1.850
	V385BO	VASCA IN ACRILICO BIANCO OPACO BATHTUB ACRYLIC MATT WHITE	2.100

DOTAZIONI VASCA BATHTUB SUPPLY

• PILETTA DI SCARICO - DRAIN-HOLE

●

• MASSIMO CONTENUTO ACQUA - MAX WATER CAPACITY

225 LT.

LEGENDA - LEGEND

● Di serie - Standard

CODICE CODE	SUPPLEMENTO PER TABELLA COLORI (SOLO ESTERNO) COLOUR CHART SUPPLEMENT (EXTERNAL ONLY)	
IB	INK BLACK	950
NB	NIGHT BLUE	950
PG	PEARL GREY	950
LS	LONDON SMOKE	950
GB	GREY BROWN	950
RR	RUBY RED	950
MC	MILK&COFFEE	950
DS	DESERT SAND	950
OW	OYSTER WHITE	950
MG	MINT GREEN	950
GT	GREEN TEA	950
BS	BLUE SKY	950
FL	FLAMINGO	950
SR	SHELL ROSE	950

Inka 180

180 x 80 x 60h

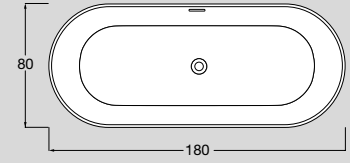
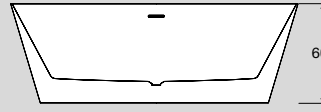

Scheda tecnica disponibile sul sito www.gruppotes.it
 Technical drawing available on www.gruppotes.it

INSTALLAZIONE / INSTALLATION

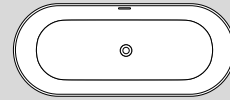

CENTRO STANZA - FREESTANDING

MODELLO MODEL	ARTICOLO ARTICLE	DESCRIZIONE DESCRIPTION	
	V388BL	VASCA IN ACRILICO BIANCO LUCIDO BATHTUB ACRYLIC GLOSSY WHITE	2.000
	V388BO	VASCA IN ACRILICO BIANCO OPACO BATHTUB ACRYLIC MATT WHITE	2.350

DOTAZIONI VASCA
 BATHTUB SUPPLY

• PILETTA DI SCARICO - DRAIN-HOLE

●

• MASSIMO CONTENUTO ACQUA - MAX WATER CAPACITY

310 LT.

LEGENDA - LEGEND

● Di serie - Standard

CODICE CODE		SUPPLEMENTO PER TABELLA COLORI (SOLO ESTERNO) COLOUR CHART SUPPLEMENT (EXTERNAL ONLY)	
IB	INK BLACK		950
NB	NIGHT BLUE		950
PG	PEARL GREY		950
LS	LONDON SMOKE		950
GB	GREY BROWN		950
RR	RUBY RED		950
MC	MILK&COFFEE		950
DS	DESERT SAND		950
OW	OYSTER WHITE		950
MG	MINT GREEN		950
GT	GREEN TEA		950
BS	BLUE SKY		950
FL	FLAMINGO		950
SR	SHELL ROSE		950

Niña 170 x 80 x 71h

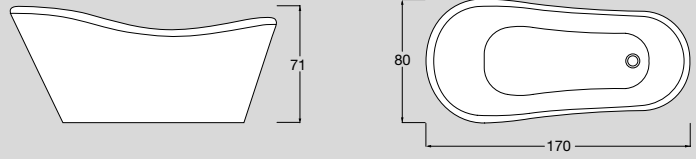

Scheda tecnica disponibile sul sito www.gruppotes.it
 Technical drawing available on www.gruppotes.it

INSTALLAZIONE / INSTALLATION

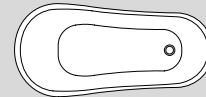

CENTRO STANZA - FREESTANDING

MODELLO MODEL	ARTICOLO ARTICLE	DESCRIZIONE DESCRIPTION	
VASCA CON PANNELLO - BATHTUB WITH PANEL			
VTL	V0371	SENZA IDROMASSAGGIO WITHOUT WHIRLPOOL	3.200

DOTAZIONI VASCA BATHTUB SUPPLY

• COLONNA DI SCARICO - DRAIN COLUMN	●
• PANNELLO DI FINITURA - FINISH PANEL	●
• MASSIMO CONTENUTO ACQUA - MAX WATER CAPACITY	165 LT.

LEGENDA - LEGEND

● Di serie - Standard

OPTIONAL VASCA BATHTUB OPTIONALS

FINOR	SUPPLEMENTO PER FINITURE ORO SURCHARGE FOR GOLDEN FINISH	100
--------------	--	------------

CODICE CODE

SUPPLEMENTO PER TABELLA COLORI (SOLO ESTERNO) COLOUR CHART SUPPLEMENT (EXTERNAL ONLY)

IB	INK BLACK	950
NB	NIGHT BLUE	950
PG	PEARL GREY	950
LS	LONDON SMOKE	950
GB	GREY BROWN	950
RR	RUBY RED	950
MC	MILK&COFFEE	950
DS	DESERT SAND	950
OW	OYSTER WHITE	950
MG	MINT GREEN	950
GT	GREEN TEA	950
BS	BLUE SKY	950
FL	FLAMINGO	950
SR	SHELL ROSE	950

Vera 150 x 72 x 55h

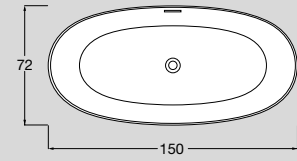
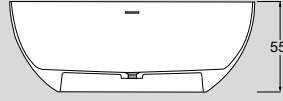

Scheda tecnica disponibile sul sito www.gruppotes.it
 Technical drawing available on www.gruppotes.it

INSTALLAZIONE / INSTALLATION

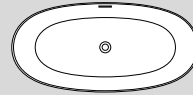

CENTRO STANZA - FREESTANDING

MODELLO MODEL	ARTICOLO ARTICLE	DESCRIZIONE DESCRIPTION	
	V065BL	VASCA IN SOLID SURFACE BIANCO LUCIDO BATHTUB IN SOLID SURFACE GLOSSY WHITE	2.700
	V065BO	VASCA IN SOLID SURFACE BIANCO OPACO BATHTUB IN SOLID SURFACE MATT WHITE	2.800

DOTAZIONI VASCA BATHTUB SUPPLY

• PILETTA DI SCARICO - DRAIN-HOLE

●

• MASSIMO CONTENUTO ACQUA - MAX WATER CAPACITY

295 LT.

LEGENDA - LEGEND

● Di serie - Standard

CODICE CODE	SUPPLEMENTO PER TABELLA COLORI (SOLO ESTERNO) COLOUR CHART SUPPLEMENT (EXTERNAL ONLY)	
IB	INK BLACK	950
NB	NIGHT BLUE	950
PG	PEARL GREY	950
LS	LONDON SMOKE	950
GB	GREY BROWN	950
RR	RUBY RED	950
MC	MILK&COFFEE	950
DS	DESERT SAND	950
OW	OYSTER WHITE	950
MG	MINT GREEN	950
GT	GREEN TEA	950
BS	BLUE SKY	950
FL	FLAMINGO	950
SR	SHELL ROSE	950

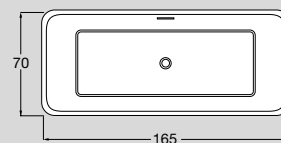
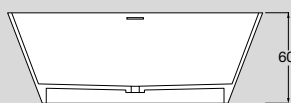

Scheda tecnica disponibile sul sito www.gruppotes.it
 Technical drawing available on www.gruppotes.it

INSTALLAZIONE / INSTALLATION

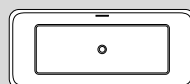

CENTRO STANZA - FREESTANDING

MODELLO MODEL	ARTICOLO ARTICLE	DESCRIZIONE DESCRIPTION	
	V286BL	VASCA IN SOLID SURFACE BIANCO LUCIDO BATHTUB IN SOLID SURFACE GLOSSY WHITE	2.900
	V286BO	VASCA IN SOLID SURFACE BIANCO OPACO BATHTUB IN SOLID SURFACE MATT WHITE	3.000

DOTAZIONI VASCA
BATHTUB SUPPLY

• PILETTA DI SCARICO - DRAIN-HOLE

●

• MASSIMO CONTENUTO ACQUA - MAX WATER CAPACITY

320 LT.

LEGENDA - LEGEND

● Di serie - Standard

CODICE CODE		SUPPLEMENTO PER TABELLA COLORI (SOLO ESTERNO) COLOUR CHART SUPPLEMENT (EXTERNAL ONLY)	
IB	INK BLACK		950
NB	NIGHT BLUE		950
PG	PEARL GREY		950
LS	LONDON SMOKE		950
GB	GREY BROWN		950
RR	RUBY RED		950
MC	MILK&COFFEE		950
DS	DESERT SAND		950
OW	OYSTER WHITE		950
MG	MINT GREEN		950
GT	GREEN TEA		950
BS	BLUE SKY		950
FL	FLAMINGO		950
SR	SHELL ROSE		950

Vasche Standard

Standard Bathtubs

73

BIS	74
EOS 160	76
EOS 190	78
QUADRA 170	80
QUADRA 180	82
QUADRA 181	84
QUADRA 199	86

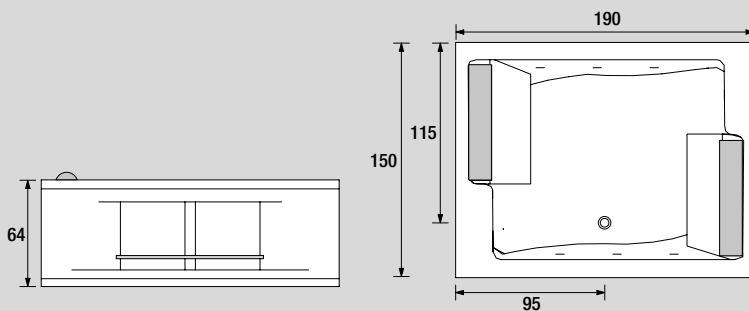

Scheda tecnica disponibile sul sito www.gruppotes.it
 Technical drawing available on www.gruppotes.it

INSTALLAZIONE / INSTALLATION

DISPONIBILE ANCHE NELLE VERSIONI: 5 - 6 - 7 - 8 (RIFERIMENTO PAG 2)

AVAILABLE ALSO IN VERSIONS: 5 - 6 - 7 - 8 (REF. PAGE 2)

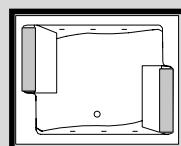

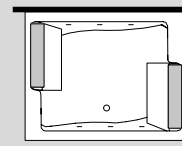

1(SX)



2(DX)

MODELLO MODEL	ARTICOLO ARTICLE	DESCRIZIONE DESCRIPTION		
VASCA CON TELAIO - BATHTUB WITH FRAME				
VTL	V5291	SENZA IDROMASSAGGIO WITHOUT WHIRLPOOL	2.600	
VASCA CON IDROMASSAGGIO - BATHTUB WITH WHIRLPOOL				
STD	STANDARD DIGITAL	V5297	IDROMASSAGGIO CON AVVIAMENTO DIGITALE WHIRLPOOL WITH DIGITAL START	5.400
STX	STANDARD EXTRA	V529B	IDROMASSAGGIO CON IMPIANTO DIGITALE E FARO SUBACQUEO WHIRLPOOL WITH DIGITAL SYSTEM AND UNDERWATER LAMP	6.000
AWA	DIGITAL AIRPOOL	V529N	IDROMASSAGGIO E AIRPOOL CON IMPIANTO DIGITALE E FARO SUBACQUEO WHIRLPOOL AND AIRPOOL WITH DIGITAL SYSTEM AND UNDERWATER LAMP	7.700

PANNELLI PER VASCA - PANELS FOR BATHTUB

	V529F	PANNELLO FRONTALE FRONTAL PANEL	450
	V529L D/S	PANNELLO LATERALE DESTRO O SINISTRO RIGHT OR LEFT SIDE PANEL	350

DOTAZIONI VASCA BATHTUB SUPPLY	VTL	STD	STX	AWA
• JET IDROMASSAGGIO - WHIRLPOOL JET	—	8	8	8
• JET AIRPOOL - AIRPOOL JET	—	—	—	24
• COLONNA DI SCARICO - DRAIN COLUMN	●	●	●	●
• CUSCINO POGGIATESTA BIANCO* - WHITE HEADREST*	2	2	2	2
• FARO SUBACQUEO - UNDERWATER LAMP	—	—	●	●
• MANIGLIA - HANDLE	2	2	2	2
• SENSORE DI LIVELLO - LEVEL SENSOR	—	●	●	●
• MASSIMO CONTENUTO ACQUA - MAX WATER CAPACITY	480 LT.	480 LT.	480 LT.	480 LT.

* Disponibile su richiesta anche nero - oro - argento e marrone

* Available on request also in black - gold - silver - brown

LEGENDA - LEGEND

● Di serie - Of series

— Non disponibile - Not available

	OPTIONAL VASCA BATHTUB OPTIONALS	STD	STX	AWA
STATA	STABILIZZATORE TEMPERATURA ACQUA - WATER TEMPERATURE STABILIZER	600	600	600
CROMO	CROMOTERAPIA - CHROMOTHERAPY	700	700	700
FINOR	SUPPLEMENTO PER FINITURE ORO - SURCHARGE FOR GOLDEN FINISH	300	300	300
BORDO	KIT PROFILO BORDO VASCA - BATHTUB EDGE SKIRTING KIT	50	50	50
SOL	SOLLEVATORE PNEUMATICO PER VASCA INCASSO - PNEUMATIC LIFT FOR BUILT-IN BATHTUB	4.500	4.500	4.500

	RUBINETTERIA TAPS		CROMO CHROME	ORO GOLD
MLQ	MISCELATORE MONOCOMANDO QUADRATO CON DEVIATORE E DOCCETTA SQUARED SINGLE-LEVER MIXER WITH DIVERTER AND HAND-SHOWER		500	800
MIX	MISCELATORE MONOCOMANDO CON DEVIATORE E DOCCETTA SINGLE-LEVER MIXER WITH DIVERTER AND HAND-SHOWER		400	650
SIF	SIFONE SCARICO VASCA PLASTIC SIPHON	40		
LINE	RUBINETTERIA ACQUA CALDA ACQUA FREDDA CON DEVIATORE E DOCCETTA SEMI-INCASSO HOT/COLD WATER TAPS WITH DIVERTER AND SEMI-BUILT IN HAND SHOWER		1.000	—
RUE	RUBINETTERIA ELETTRONICA CON DEVIATORE E DOCCETTA SEMI-INCASSO ELECTRONIC WATER TAPS WITH DIVERTER AND SEMI-BUILT IN HAND SHOWER		1.500	—
BVG	BOCCA A VELA GRANDE LARGE SAIL-SHAPED		900	1.100
FOR	SUPPLEMENTO PER FORATURA RUBINETTERIA DIVERSA DA QUELLE PRESENTI SUL NOSTRO LISTINO SURCHARGE FOR TAPS DRILLING IF TAPS ARE NOT OUR MODELS	500		

Eos 160 $\varnothing 160 \times 66h$

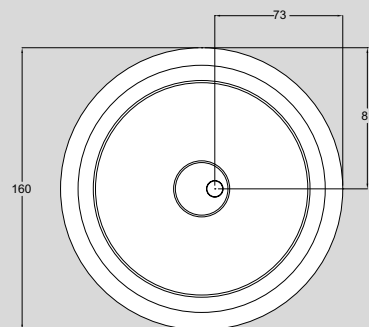

Scheda tecnica disponibile sul sito www.gruppotes.it
 Technical drawing available on www.gruppotes.it

INSTALLAZIONE / INSTALLATION

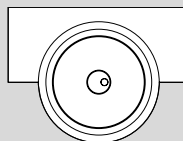

SEMI INCASSO / SEMI BUILT-IN

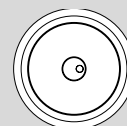

CENTROSTANZA / FREESTANDING

MODELLO MODEL	ARTICOLO ARTICLE	DESCRIZIONE DESCRIPTION	
VASCA CON TELAIO - BATHTUB WITH FRAME			
VTL	V8461	SENZA IDROMASSAGGIO WITHOUT WHIRLPOOL	2.500
VASCA CON IDROMASSAGGIO - BATHTUB WITH WHIRLPOOL			
STX	STANDARD EXTRA	V846B	IDROMASSAGGIO CON IMPIANTO DIGITALE E FARO SUBACQUEO WHIRLPOOL WITH DIGITAL SYSTEM AND UNDERWATER LAMP
AWA	DIGITAL AIRPOOL	V846N	IDROMASSAGGIO E AIRPOOL CON IMPIANTO DIGITALE E FARO SUBACQUEO WHIRLPOOL AND AIRPOOL WITH DIGITAL SYSTEM AND UNDERWATER LAMP
			5.500
			7.300

PANNELLI PER VASCA - PANELS FOR BATHTUB

	V836FX	PANNELLO PER INSTALLAZIONE SEMI INCASSO PANEL FOR SEMI BUILT-IN INSTALLATION	450
	V836FX 2	PANNELLI PER INSTALLAZIONE CENTRO STANZA PANELS FOR FREESTANDING INSTALLATION	900

DOTAZIONI VASCA BATHTUB SUPPLY	VTL	STX	AWA
• JET IDROMASSAGGIO - WHIRLPOOL JET	—	12	12
• JET AIRPOOL - AIRPOOL JET	—	—	18
• COLONNA DI SCARICO - DRAIN COLUMN	●	●	●
• SENSORE DI LIVELLO - LEVEL SENSOR	—	●	●
• FARO SUBACQUEO - UNDERWATER LAMP	—	●	●
• MASSIMO CONTENUTO ACQUA - MAX WATER CAPACITY	300 LT.	300 LT.	300 LT.

LEGENDA - LEGEND

- Di serie - Of series
- Non disponibile - Not available

	OPTIONAL VASCA BATHTUB OPTIONALS	STX	AWA
STATA	STABILIZZATORE TEMPERATURA ACQUA - WATER TEMPERATURE STABILIZER	600	600
CROMO	CROMOTERAPIA - CHROMOTHERAPY	700	700
SOL	SOLLEVATORE PNEUMATICO PER VASCA INCASSO - PNEUMATIC LIFT FOR BUILT-IN BATHTUB	4.500	4.500

	RUBINETTERIA TAPS		CROMO CHROME
RUE	RUBINETTERIA ELETTRONICA CON DEVIATORE E DOCCETTA SEMI-INCASSO ELECTRONIC WATER TAPS WITH DIVERTER AND SEMI-BUILT IN HAND SHOWER		1.500
ERF	RIEMPIMENTO VASCA DAL FONDO FILLING BATHTUB FROM THE BOTTOM		250
MIX	MISCELATORE MONOCOMANDO CON DEVIATORE E DOCCETTA SINGLE-LEVER MIXER WITH DIVERTER AND HAND-SHOWER		400
SIF	SIFONE SCARICO VASCA PLASTIC SIPHON	40	
FOR	SUPPLEMENTO PER FORATURA RUBINETTERIA DIVERSA DA QUELLE PRESENTI SUL NOSTRO LISTINO SURCHARGE FOR TAPS DRILLING IF TAPS ARE NOT OUR MODELS	500	

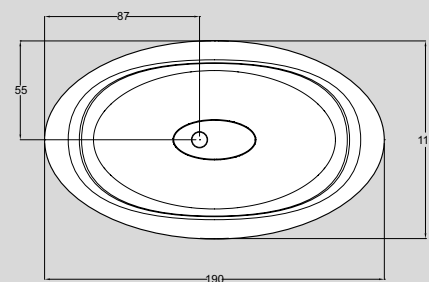

Scheda tecnica disponibile sul sito www.gruppotes.it
 Technical drawing available on www.gruppotes.it

INSTALLAZIONE / INSTALLATION

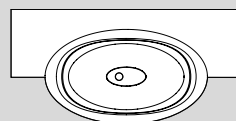

SEMI INCASSO / SEMI BUILT-IN

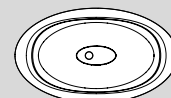

CENTROSTANZA / FREESTANDING

MODELLO MODEL	ARTICOLO ARTICLE	DESCRIZIONE DESCRIPTION		
VASCA CON TELAIO - BATHTUB WITH FRAME				
VTL	V8491	SENZA IDROMASSAGGIO WITHOUT WHIRLPOOL	2.500	
VASCA CON IDROMASSAGGIO - BATHTUB WITH WHIRLPOOL				
STX	STANDARD EXTRA	V849B	IDROMASSAGGIO CON IMPIANTO DIGITALE E FARO SUBACQUEO WHIRLPOOL WITH DIGITAL SYSTEM AND UNDERWATER LAMP	5.500
AWA	DIGITAL AIRPOOL	V849N	IDROMASSAGGIO E AIRPOOL CON IMPIANTO DIGITALE E FARO SUBACQUEO WHIRLPOOL AND AIRPOOL WITH DIGITAL SYSTEM AND UNDERWATER LAMP	7.300

PANNELLI PER VASCA - PANELS FOR BATHTUB

	V839FX	PANNELLO PER INSTALLAZIONE SEMI INCASSO PANEL FOR INSTALLATION SEMI BUILT-IN	450
	V839FX 2	PANNELLI PER INSTALLAZIONE CENTRO STANZA PANELS FOR INSTALLATION FREESTANDING	900

DOTAZIONI VASCA BATHTUB SUPPLY	VTL	STX	AWA
• JET IDROMASSAGGIO - WHIRLPOOL JET	—	12	12
• JET AIRPOOL - AIRPOOL JET	—	—	18
• COLONNA DI SCARICO - DRAIN COLUMN	●	●	●
• SENSORE DI LIVELLO - LEVEL SENSOR	—	●	●
• FARO SUBACQUEO - UNDERWATER LAMP	—	●	●
• MASSIMO CONTENUTO ACQUA - MAX WATER CAPACITY	280 LT.	280 LT.	280 LT.

LEGENDA - LEGEND

- Di serie - Of series
- Non disponibile - Not available

	OPTIONAL VASCA BATHTUB OPTIONALS	STX	AWA
STATA	STABILIZZATORE TEMPERATURA ACQUA - WATER TEMPERATURE STABILIZER	600	600
CROMO	CROMOTERAPIA - CHROMOTHERAPY	700	700
SOL	SOLLEVATORE PNEUMATICO PER VASCA INCASSO - PNEUMATIC LIFT FOR BUILT-IN BATHTUB	4.500	4.500

	RUBINETTERIA TAPS		CROMO CHROME
RUE	RUBINETTERIA ELETTRONICA CON DEVIATORE E DOCCETTA SEMI-INCASSO ELECTRONIC WATER TAPS WITH DIVERTER AND SEMI-BUILT IN HAND SHOWER		1.500
ERF	RIEMPIMENTO VASCA DAL FONDO FILLING BATHTUB FROM THE BOTTOM		250
MIX	MISCELATORE MONOCOMANDO CON DEVIATORE E DOCCETTA SINGLE-LEVER MIXER WITH DIVERTER AND HAND-SHOWER		400
SIF	SIFONE SCARICO VASCA PLASTIC SIPHON	40	
FOR	SUPPLEMENTO PER FORATURA RUBINETTERIA DIVERSA DA QUELLE PRESENTI SUL NOSTRO LISTINO SURCHARGE FOR TAPS DRILLING IF TAPS ARE NOT OUR MODELS	500	

Quadra 170

170 x 70 x 65h

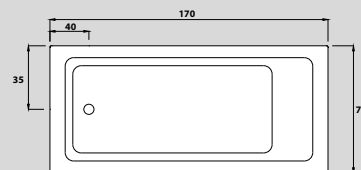

Scheda tecnica disponibile sul sito www.gruppotes.it
 Technical drawing available on www.gruppotes.it

INSTALLAZIONE / INSTALLATION

DISPONIBILE ANCHE NELLE VERSIONI: 5 - 6 - 7 - 8 (RIFERIMENTO PAG 2)

AVAILABLE ALSO IN VERSIONS: 5 - 6 - 7 - 8 (REF. PAGE 2)

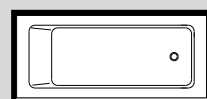

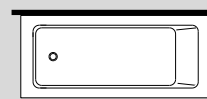

1(SX)



2(DX)

MODELLO MODEL	ARTICOLO ARTICLE	DESCRIZIONE DESCRIPTION		
VASCA INCASSO - BUILT-IN BATHTUB				
VIN	V0720	INCASSO BUILT-IN	650	
VASCA CON TELAIO - BATHTUB WITH FRAME				
VTL	V0721	SENZA IDROMASSAGGIO WITHOUT WHIRLPOOL	950	
VASCA CON IDROMASSAGGIO - BATHTUB WITH WHIRLPOOL				
STD	STANDARD DIGITALE	V0727	IDROMASSAGGIO CON AVVIAMENTO DIGITALE WHIRLPOOL WITH DIGITAL START	2.300
STX	STANDARD EXTRA	V072B	IDROMASSAGGIO CON IMPIANTO DIGITALE E FARO SUBACQUEO WHIRLPOOL WITH DIGITAL SYSTEM AND UNDERWATER LAMP	2.900
AWA	DIGITAL WHIRLPOOL AIRPOOL	V072N	IDROMASSAGGIO E AIRPOOL CON IMPIANTO DIGITALE E FARO SUBACQUEO WHIRLPOOL AND AIRPOOL WITH DIGITAL SYSTEM AND UNDERWATER LAMP	4.600

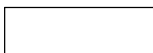
PANNELLI PER VASCA - PANELS FOR BATHTUB

	V077F	PANNELLO FRONTALE FRONTAL PANEL	350
	V077L D/S	PANNELLO LATERALE DESTRO O SINISTRO RIGHT OR LEFT SIDE PANEL	300

DOTAZIONI VASCA BATHTUB SUPPLY	VIN-VTL	STD	STX	AWA
• JET IDROMASSAGGIO - WHIRLPOOL JET	—	6	6	6
• JET AIRPOOL - AIRPOOL JET	—	—	—	12
• COLONNA DI SCARICO - DRAIN COLUMN	●	●	●	●
• SENSORE DI LIVELLO - LEVEL SENSOR	—	●	●	●
• FARO SUBACQUEO - UNDERWATER LAMP	—	—	●	●
• MASSIMO CONTENUTO ACQUA - MAX WATER CAPACITY	170 LT.	170 LT.	170 LT.	170 LT.

LEGENDA - LEGEND

- Di serie - Of series
- Non disponibile - Not available

	OPTIONAL VASCA BATHTUB OPTIONALS	STD	STX	AWA
STATA	STABILIZZATORE TEMPERATURA ACQUA - WATER TEMPERATURE STABILIZER	600	600	600
CROMO	CROMOTERAPIA - CHROMOTHERAPY	700	700	700
BORDO	KIT PROFILO BORDO VASCA - BATHTUB EDGE SKIRTING KIT	50	50	50
078CU	CUSCINO POGGIATESTA MORBIDO (NERO*) - SOFT PILLOW HEADREST (BLACK*)	150	150	150
FINOR	SUPPLEMENTO PER FINITURE ORO - SURCHARGE FOR GOLDEN FINISH	300	300	300

* Disponibile su richiesta anche bianco / Available on request also in white

	RUBINETTERIA* TAPS*		CROMO CHROME	ORO GOLD
MIX	MISCELATORE MONOCOMANDO CON DEVIATORE E DOCCETTA SINGLE-LEVER MIXER WITH DIVERTER AND HAND-SHOWER		400	650
MLQ	MISCELATORE MONOCOMANDO QUADRATO CON DEVIATORE E DOCCETTA SQUARED SINGLE-LEVER MIXER WITH DIVERTER AND HAND-SHOWER		500	800
RUE	RUBINETTERIA ELETTRONICA CON DEVIATORE E DOCCETTA SEMI-INCASSO ELECTRONIC WATER TAPS WITH DIVERTER AND SEMI-BUILT IN HAND SHOWER		1.500	—
BVP	BOCCA A VELA PICCOLA SMALL SAIL-SHAPED		200	—
BVC	BOCCA A VELA PICCOLA MODELLO CUBO SMALL SAIL-SHAPED CUBO MODEL		200	—
COE	SUPPLEMENTO PER COLONNA DI SCARICO CON EROGAZIONE SURCHARGE FOR DRAIN COLUMN WITH WATER OUTLET		80	100
SIF	SIFONE SCARICO VASCA PLASTIC SIPHON	40		
FOR	SUPPLEMENTO PER FORATURA RUBINETTERIA DIVERSA DA QUELLE PRESENTI SUL NOSTRO LISTINO SURCHARGE FOR TAPS DRILLING IF TAPS ARE NOT OUR MODELS	500		

Quadra 180

180 x 80 x 65h

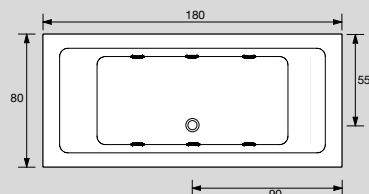

Scheda tecnica disponibile sul sito www.gruppotes.it
 Technical drawing available on www.gruppotes.it

INSTALLAZIONE / INSTALLATION

DISPONIBILE ANCHE NELLE VERSIONI: 5 - 6 - 7 - 8 (RIFERIMENTO PAG 2)

AVAILABLE ALSO IN VERSIONS: 5 - 6 - 7 - 8 (REF. PAGE 2)

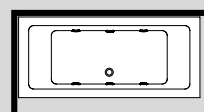

1(SX)

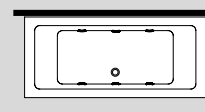

2(DX)

MODELLO MODEL	ARTICOLO ARTICLE	DESCRIZIONE DESCRIPTION		
VASCA INCASSO - BUILT-IN BATHTUB				
VIN	V0780	INCASSO BUILT-IN	650	
VASCA CON TELAIO - BATHTUB WITH FRAME				
VTL	V0781	SENZA IDROMASSAGGIO WITHOUT WHIRLPOOL	1.050	
VASCA CON IDROMASSAGGIO - BATHTUB WITH WHIRLPOOL				
STD	STANDARD DIGITALE	V0787	IDROMASSAGGIO CON AVVIAMENTO DIGITALE WHIRLPOOL WITH DIGITAL START	2.500
STX	STANDARD EXTRA	V078B	IDROMASSAGGIO CON IMPIANTO DIGITALE E FARO SUBACQUEO WHIRLPOOL WITH DIGITAL SYSTEM AND UNDERWATER LAMP	3.150
AWA	DIGITAL WHIRLPOOL AIRPOOL	V078N	IDROMASSAGGIO E AIRPOOL CON IMPIANTO DIGITALE E FARO SUBACQUEO WHIRLPOOL AND AIRPOOL WITH DIGITAL SYSTEM AND UNDERWATER LAMP	4.700

PANNELLI PER VASCA - PANELS FOR BATHTUB

	V078F	PANNELLO FRONTALE FRONTAL PANEL	350
	V078L D/S	PANNELLO LATERALE DESTRO O SINISTRO RIGHT OR LEFT SIDE PANEL	300

DOTAZIONI VASCA BATHTUB SUPPLY	VIN-VTL	STD	STX	AWA
• JET IDROMASSAGGIO - WHIRLPOOL JET	—	6	6	6
• JET AIRPOOL - AIRPOOL JET	—	—	—	12
• COLONNA DI SCARICO - DRAIN COLUMN	●	●	●	●
• SENSORE DI LIVELLO - LEVEL SENSOR	—	●	●	●
• FARO SUBACQUEO - UNDERWATER LAMP	—	—	●	●
• MASSIMO CONTENUTO ACQUA - MAX WATER CAPACITY	200 LT.	200 LT.	200 LT.	200 LT.

LEGENDA - LEGEND

- Di serie - Of series
- Non disponibile - Not available

	OPTIONAL VASCA BATHTUB OPTIONALS	STD	STX	AWA
STATA	STABILIZZATORE TEMPERATURA ACQUA - WATER TEMPERATURE STABILIZER	600	600	600
CROMO	CROMOTERAPIA - CHROMOTHERAPY	700	700	700
BORDO	KIT PROFILO BORDO VASCA - BATHTUB EDGE SKIRTING KIT	50	50	50
078CU	CUSCINO POGGIATESTA MORBIDO (NERO*) - SOFT PILLOW HEADREST (BLACK*)	150	150	150
FINOR	SUPPLEMENTO PER FINITURE ORO - SURCHARGE FOR GOLDEN FINISH	300	300	300

* Disponibile su richiesta anche bianco / Available on request also in white

	RUBINETTERIA TAPS		CROMO CHROME	ORO GOLD
MIX	MISCELATORE MONOCOMANDO CON DEVIATORE E DOCCETTA SINGLE-LEVER MIXER WITH DIVERTER AND HAND-SHOWER		400	650
MLQ	MISCELATORE MONOCOMANDO QUADRATO CON DEVIATORE E DOCCETTA SQUARED SINGLE-LEVER MIXER WITH DIVERTER AND HAND-SHOWER		500	800
LINE	RUBINETTERIA ACQUA CALDA ACQUA FREDDA CON DEVIATORE E DOCCETTA SEMI-INCASSO HOT/COLD WATER TAPS WITH DIVERTER AND SEMI-BUILT IN HAND SHOWER		1.000	—
RUE	RUBINETTERIA ELETTRONICA CON DEVIATORE E DOCCETTA SEMI-INCASSO ELECTRONIC WATER TAPS WITH DIVERTER AND SEMI-BUILT IN HAND SHOWER		1.500	—
BVP	BOCCA A VELA PICCOLA SMALL SAIL-SHAPED		200	—
BVC	BOCCA A VELA PICCOLA MODELLO CUBO SMALL SAIL-SHAPED CUBO MODEL		200	—
COE	SUPPLEMENTO PER COLONNA DI SCARICO CON EROGAZIONE SURCHARGE FOR DRAIN COLUMN WITH WATER OUTLET		80	100
SIF	SIFONE SCARICO VASCA PLASTIC SIPHON	40		
FOR	SUPPLEMENTO PER FORATURA RUBINETTERIA DIVERSA DA QUELLE PRESENTI SUL NOSTRO LISTINO SURCHARGE FOR TAPS DRILLING IF TAPS ARE NOT OUR MODELS	500		

Quadra 181

180 x 100 x 67h

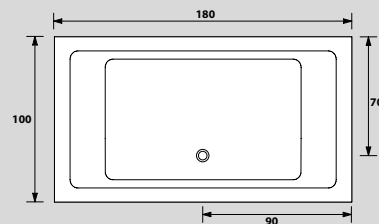

Scheda tecnica disponibile sul sito www.gruppotes.it
 Technical drawing available on www.gruppotes.it

INSTALLAZIONE / INSTALLATION

DISPONIBILE ANCHE NELLE VERSIONI: 5 - 6 - 7 - 8 (RIFERIMENTO PAG 2)

AVAILABLE ALSO IN VERSIONS: 5 - 6 - 7 - 8 (REF. PAGE 2)

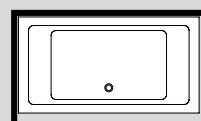

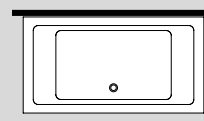

1(SX)



2(DX)

MODELLO MODEL	ARTICOLO ARTICLE	DESCRIZIONE DESCRIPTION		
VASCA INCASSO - BUILT-IN BATHTUB				
VIN	V0710	INCASSO BUILT-IN	850	
VASCA CON TELAIO - BATHTUB WITH FRAME				
VTL	V0711	SENZA IDROMASSAGGIO WITHOUT WHIRLPOOL	1.250	
VASCA CON IDROMASSAGGIO - BATHTUB WITH WHIRLPOOL				
STD	STANDARD DIGITALE	V0717	IDROMASSAGGIO CON AVVIAMENTO DIGITALE WHIRLPOOL WITH DIGITAL START	2.700
STX	STANDARD EXTRA	V071B	IDROMASSAGGIO CON IMPIANTO DIGITALE E FARO SUBACQUEO WHIRLPOOL WITH DIGITAL SYSTEM AND UNDERWATER LAMP	3.300
AWA	DIGITAL WHIRLPOOL AIRPOOL	V071N	IDROMASSAGGIO E AIRPOOL CON IMPIANTO DIGITALE E FARO SUBACQUEO WHIRLPOOL AND AIRPOOL WITH DIGITAL SYSTEM AND UNDERWATER LAMP	4.900

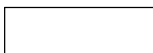
PANNELLI PER VASCA - PANELS FOR BATHTUB

	V078F	PANNELLO FRONTALE FRONTAL PANEL	350
	V071L D/S	PANNELLO LATERALE DESTRO O SINISTRO RIGHT OR LEFT SIDE PANEL	300

DOTAZIONI VASCA BATHTUB SUPPLY	VIN-VTL	STD	STX	AWA
• JET IDROMASSAGGIO - WHIRLPOOL JET	—	6	6	6
• JET AIRPOOL - AIRPOOL JET	—	—	—	18
• COLONNA DI SCARICO - DRAIN COLUMN	●	●	●	●
• SENSORE DI LIVELLO - LEVEL SENSOR	—	●	●	●
• FARO SUBACQUEO - UNDERWATER LAMP	—	—	●	●
• MASSIMO CONTENUTO ACQUA - MAX WATER CAPACITY	240 LT.	240 LT.	240 LT.	240 LT.

LEGENDA - LEGEND

- Di serie - Of series
- Non disponibile - Not available

	OPTIONAL VASCA BATHTUB OPTIONALS	STD	STX	AWA
STATA	STABILIZZATORE TEMPERATURA ACQUA - WATER TEMPERATURE STABILIZER	600	600	600
CROMO	CROMOTERAPIA - CHROMOTHERAPY	700	700	700
BORDO	KIT PROFILO BORDO VASCA - BATHTUB EDGE SKIRTING KIT	50	50	50
078CU	CUSCINO POGGIATESTA MORBIDO (NERO*) - SOFT PILLOW HEADREST (BLACK*)	150	150	150
FINOR	SUPPLEMENTO PER FINITURE ORO - SURCHARGE FOR GOLDEN FINISH	300	300	300

* Disponibile su richiesta anche bianco / Available on request also in white

	RUBINETTERIA TAPS		CROMO CHROME	ORO GOLD
MIX	MISCELATORE MONOCOMANDO CON DEVIATORE E DOCCETTA SINGLE-LEVER MIXER WITH DIVERTER AND HAND-SHOWER		400	650
MLQ	MISCELATORE MONOCOMANDO QUADRATO CON DEVIATORE E DOCCETTA SQUARED SINGLE-LEVER MIXER WITH DIVERTER AND HAND-SHOWER		500	800
LINE	RUBINETTERIA ACQUA CALDA ACQUA FREDDA CON DEVIATORE E DOCCETTA SEMI-INCASSO HOT/COLD WATER TAPS WITH DIVERTER AND SEMI-BUILT IN HAND SHOWER		1.000	—
RUE	RUBINETTERIA ELETTRONICA CON DEVIATORE E DOCCETTA SEMI-INCASSO ELECTRONIC WATER TAPS WITH DIVERTER AND SEMI-BUILT IN HAND SHOWER		1.500	—
BVP	BOCCA A VELA PICCOLA SMALL SAIL-SHAPED		200	—
BVC	BOCCA A VELA PICCOLA MODELLO CUBO SMALL SAIL-SHAPED CUBO MODEL		200	—
COE	SUPPLEMENTO PER COLONNA DI SCARICO CON EROGAZIONE SURCHARGE FOR DRAIN COLUMN WITH WATER OUTLET		80	100
SIF	SIFONE SCARICO VASCA PLASTIC SIPHON	40		
FOR	SUPPLEMENTO PER FORATURA RUBINETTERIA DIVERSA DA QUELLE PRESENTI SUL NOSTRO LISTINO SURCHARGE FOR TAPS DRILLING IF TAPS ARE NOT OUR MODELS	500		

Quadra 199

190 x 90 x 67h

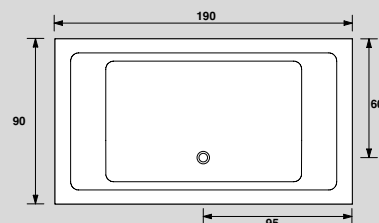

Scheda tecnica disponibile sul sito www.gruppotes.it
 Technical drawing available on www.gruppotes.it

INSTALLAZIONE / INSTALLATION

DISPONIBILE ANCHE NELLE VERSIONI: 5 - 6 - 7 - 8 (RIFERIMENTO PAG 2)

AVAILABLE ALSO IN VERSIONS: 5 - 6 - 7 - 8 (REF. PAGE 2)

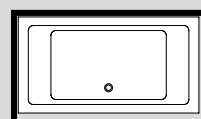

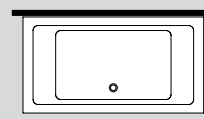

1(SX)



2(DX)

MODELLO MODEL	ARTICOLO ARTICLE	DESCRIZIONE DESCRIPTION		
VASCA INCASSO - BUILT-IN BATHTUB				
VIN	V0730	INCASSO BUILT-IN	850	
VASCA CON TELAIO - BATHTUB WITH FRAME				
VTL	V0731	SENZA IDROMASSAGGIO WITHOUT WHIRLPOOL	1.250	
VASCA CON IDROMASSAGGIO - BATHTUB WITH WHIRLPOOL				
STD	STANDARD DIGITALE	V0737	IDROMASSAGGIO CON AVVIAMENTO DIGITALE WHIRLPOOL WITH DIGITAL START	2.700
STX	STANDARD EXTRA	V073B	IDROMASSAGGIO CON IMPIANTO DIGITALE E FARO SUBACQUEO WHIRLPOOL WITH DIGITAL SYSTEM AND UNDERWATER LAMP	3.300
AWA	DIGITAL WHIRLPOOL AIRPOOL	V073N	IDROMASSAGGIO E AIRPOOL CON IMPIANTO DIGITALE E FARO SUBACQUEO WHIRLPOOL AND AIRPOOL WITH DIGITAL SYSTEM AND UNDERWATER LAMP	4.900

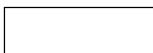
PANNELLI PER VASCA - PANELS FOR BATHTUB

	V073F	PANNELLO FRONTALE FRONTAL PANEL	350
	V073L D/S	PANNELLO LATERALE DESTRO O SINISTRO RIGHT OR LEFT SIDE PANEL	300

DOTAZIONI VASCA BATHTUB SUPPLY	VIN-VTL	STD	STX	AWA
• JET IDROMASSAGGIO - WHIRLPOOL JET	—	6	6	6
• JET AIRPOOL - AIRPOOL JET	—	—	—	18
• COLONNA DI SCARICO - DRAIN COLUMN	●	●	●	●
• SENSORE DI LIVELLO - LEVEL SENSOR	—	●	●	●
• FARO SUBACQUEO - UNDERWATER LAMP	—	—	●	●
• MASSIMO CONTENUTO ACQUA - MAX WATER CAPACITY	240 LT.	240 LT.	240 LT.	240 LT.

LEGENDA - LEGEND

- Di serie - Of series
- Non disponibile - Not available

	OPTIONAL VASCA BATHTUB OPTIONALS	STD	STX	AWA
STATA	STABILIZZATORE TEMPERATURA ACQUA - WATER TEMPERATURE STABILIZER	600	600	600
CROMO	CROMOTERAPIA - CHROMOTHERAPY	700	700	700
BORDO	KIT PROFILO BORDO VASCA - BATHTUB EDGE SKIRTING KIT	50	50	50
078CU	CUSCINO POGGIATESTA MORBIDO (NERO*) - SOFT PILLOW HEADREST (BLACK*)	150	150	150
FINOR	SUPPLEMENTO PER FINITURE ORO - SURCHARGE FOR GOLDEN FINISH	300	300	300

* Disponibile su richiesta anche bianco / Available on request also in white

	RUBINETTERIA TAPS		CROMO CHROME	ORO GOLD
MIX	MISCELATORE MONOCOMANDO CON DEVIATORE E DOCCETTA SINGLE-LEVER MIXER WITH DIVERTER AND HAND-SHOWER		400	650
MLQ	MISCELATORE MONOCOMANDO QUADRATO CON DEVIATORE E DOCCETTA SQUARED SINGLE-LEVER MIXER WITH DIVERTER AND HAND-SHOWER		500	800
LINE	RUBINETTERIA ACQUA CALDA ACQUA FREDDA CON DEVIATORE E DOCCETTA SEMI-INCASSO HOT/COLD WATER TAPS WITH DIVERTER AND SEMI-BUILT IN HAND SHOWER		1.000	—
RUE	RUBINETTERIA ELETTRONICA CON DEVIATORE E DOCCETTA SEMI-INCASSO ELECTRONIC WATER TAPS WITH DIVERTER AND SEMI-BUILT IN HAND SHOWER		1.500	—
BVP	BOCCA A VELA PICCOLA SMALL SAIL-SHAPED		200	—
BVC	BOCCA A VELA PICCOLA MODELLO CUBO SMALL SAIL-SHAPED CUBO MODEL		200	—
COE	SUPPLEMENTO PER COLONNA DI SCARICO CON EROGAZIONE SURCHARGE POP UP & OVERFLOW WITH WATER OUTLET SPOUT		80	100
SIF	SIFONE SCARICO VASCA PLASTIC SIPHON	40		
FOR	SUPPLEMENTO PER FORATURA RUBINETTERIA DIVERSA DA QUELLE PRESENTI SUL NOSTRO LISTINO SURCHARGE FOR TAPS DRILLING IF TAPS ARE NOT OUR MODELS	500		

AURA (VETRO FRONTALE/FRONT GLASS)	90
AURA (CON VETRO LATERALE/WITH LATERAL GLASS)	91
MIRAGE	92

(1 LATO VETRO/1 PANE OF GLASS)

(160x120x216h - 180x120x216h - 180x150x216h - 200x150x216h - 200x200x216h)

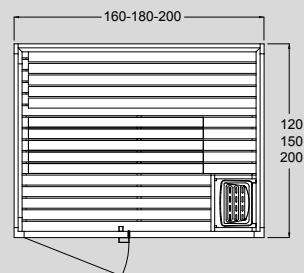
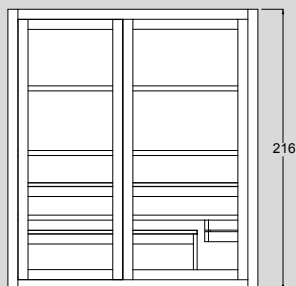

Scheda tecnica disponibile sul sito www.gruppotres.it
 Technical drawing available on www.gruppotres.it

INSTALLAZIONI DISPONIBILI AVAILABLE INSTALLATIONS

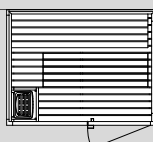

SX

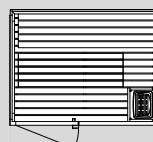

DX

RIFERIMENTO PAG. 3
 REF. PAGE 3

ARTICOLO ARTICLE	DESCRIZIONE DESCRIPTION	
SAUNA		
SA1612AA	SAUNA CON COMANDO DIGITALE (160X120) COMPLETA DI STUFA DA 3 KW SAUNA WITH DIGITAL CONTROL (160X120) COMPLETE WITH 3 KW STOVE	11.000
SA1812AA	SAUNA CON COMANDO DIGITALE (180X120) COMPLETA DI STUFA DA 4,5 KW SAUNA WITH DIGITAL CONTROL (180X120) COMPLETE WITH 4,5 KW STOVE	11.500
SA1815AA	SAUNA CON COMANDO DIGITALE (180X150) COMPLETA DI STUFA DA 4,5 KW SAUNA WITH DIGITAL CONTROL (180X150) COMPLETE WITH 4,5 KW STOVE	12.000
SA2015AA	SAUNA CON COMANDO DIGITALE (200X150) COMPLETA DI STUFA DA 6 KW SAUNA WITH DIGITAL CONTROL (200X150) COMPLETE WITH 6 KW STOVE	12.000
SA2020AA	SAUNA CON COMANDO DIGITALE (200X200) COMPLETA DI STUFA DA 6 KW SAUNA WITH DIGITAL CONTROL (200X200) COMPLETE WITH 6 KW STOVE	16.100

DOTAZIONI SAUNA SAUNA FEATURES

• MATERIALE: ABETE - FRASSINO TERMOTRATTATO - MATERIAL: SPRUCE - HEAT-TREATED ASH	●
• STUFA - STOVE	●
• CLESSIDRA - HOURGLASS	●
• TERMOIGROMETRO - THERMO HYGROMETER	●
• CESTELLO CON MESTOLO - BUCKET WITH LADLE	●
• POGGIATESTA - HEADREST	●
• ILLUMINAZIONE A LED - LED LIGHTING	●

LEGENDA - LEGEND

● Di serie - Standard

	OPTIONAL SAUNA SAUNA OPTIONALS	
LED	ILLUMINAZIONE A LED DELUXE - LED LIGHTING DELUXE	600
MIS	SUPPLEMENTO PER SAUNA SU MISURA* - SUPPLEMENT FOR CUSTOM-MADE SAUNA* L 160 - 200 CM / P 120 - 200 CM	+35%

*IL SUPPLEMENTO VA CALCOLATO SUL PREZZO DELLA SAUNA DI MQ IMMEDIATAMENTE SUPERIORE

THE SUPPLEMENT SHALL BE CALCULATED ON THE PRICE OF THE SAUNA OF AN AREA IMMEDIATELY ABOVE THE PRICE OF THE SAUNA

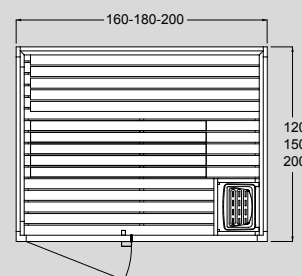
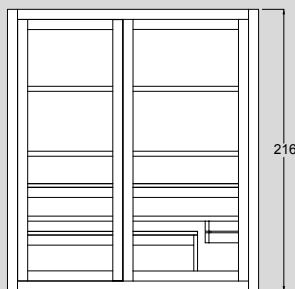

Scheda tecnica disponibile sul sito www.gruppotres.it
 Technical drawing available on www.gruppotres.it

INSTALLAZIONI DISPONIBILI
 AVAILABLE INSTALLATIONS

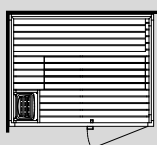

SX

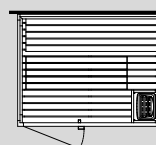

DX

RIFERIMENTO PAG. 3
 REF. PAGE 3

ARTICOLO ARTICLE	DESCRIZIONE DESCRIPTION	
SAUNA		
SA1612AV	SAUNA CON COMANDO DIGITALE (160X120) COMPLETA DI STUFA DA 3 KW SAUNA WITH DIGITAL CONTROL (160X120) COMPLETE WITH 3 KW STOVE	12.600
SA1812AV	SAUNA CON COMANDO DIGITALE (180X120) COMPLETA DI STUFA DA 4,5 KW SAUNA WITH DIGITAL CONTROL (180X120) COMPLETE WITH 4,5 KW STOVE	13.100
SA1815AV	SAUNA CON COMANDO DIGITALE (180X150) COMPLETA DI STUFA DA 4,5 KW SAUNA WITH DIGITAL CONTROL (180X150) COMPLETE WITH 4,5 KW STOVE	13.600
SA2015AV	SAUNA CON COMANDO DIGITALE (200X150) COMPLETA DI STUFA DA 6 KW SAUNA WITH DIGITAL CONTROL (200X150) COMPLETE WITH 6 KW STOVE	13.600
SA2020AV	SAUNA CON COMANDO DIGITALE (200X200) COMPLETA DI STUFA DA 6 KW SAUNA WITH DIGITAL CONTROL (200X200) COMPLETE WITH 6 KW STOVE	19.100

DOTAZIONI SAUNA SAUNA FEATURES	
• MATERIALE: ABETE - FRASSINO TERMOTRATTATO - MATERIAL: SPRUCE - HEAT-TREATED ASH	●
• STUFA - STOVE	●
• CLESSIDRA - HOURGLASS	●
• TERMOIGROMETRO - THERMO HYGROMETER	●
• CESTELLO CON MESTOLO - BUCKET WITH LADLE	●
• POGGIATESTA - HEADREST	●
• ILLUMINAZIONE A LED - LED LIGHTING	●

LEGGENDA - LEGEND

● **Di serie** - Standard

	OPTIONAL SAUNA SAUNA OPTIONALS	
LED	ILLUMINAZIONE A LED DELUXE - LED LIGHTING DELUXE	600
MIS	SUPPLEMENTO PER SAUNA SU MISURA* - SUPPLEMENT FOR CUSTOM-MADE SAUNA* L 160 - 200 CM / P 120 - 200 CM	+35%

*IL SUPPLEMENTO VA CALCOLATO SUL PREZZO DELLA SAUNA DI MQ IMMEDIATAMENTE SUPERIORE

THE SUPPLEMENT SHALL BE CALCULATED ON THE PRICE OF THE SAUNA OF AN AREA IMMEDIATELY ABOVE THE PRICE OF THE SAUNA

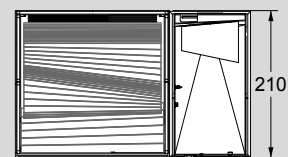
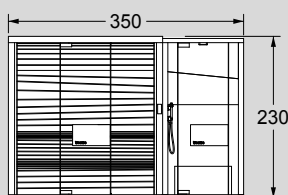

Scheda tecnica disponibile sul sito www.gruppotes.it
 Technical drawing available on www.gruppotes.it

INSTALLAZIONI DISPONIBILI AVAILABLE INSTALLATIONS

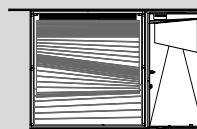
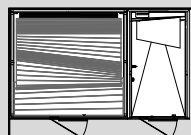

CENTRO PARETE

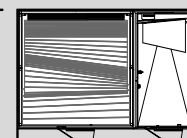

NICCHIA

ARTICOLO ARTICLE	DESCRIZIONE DESCRIPTION	
SAUNA		
S13521	COMBINATO SAUNA + BAGNO TURCO COMBINED SAUNA + STEAM BATH	58.000

DOTAZIONI SAUNA SAUNA FEATURES

- | | |
|--|---|
| • MATERIALE: ABETE - FRASSINO TERMOTRATTATO - MATERIAL: SPRUCE - HEAT-TREATED ASH | ● |
| • STUFA - STOVE | ● |
| • CLESSIDRA - HOURGLASS | ● |
| • TERMOIGROMETRO - THERMO HYGROMETER | ● |
| • CESTELLO CON MESTOLO - BUCKET WITH LADLE | ● |
| • POGGIATESTA - HEADREST | ● |
| • ILLUMINAZIONE A LED - LED LIGHTING | ● |

DOTAZIONI BAGNO TURCO STEAM FEATURES

- | | |
|---|---|
| • RUBINETTERIA CON DOCCINO - TAP SET WITH SHOWER | ● |
| • SOFFIONE DOCCIA - SHOWER HEAD | ● |
| • GENERATORE VAPORE - STEAM GENERATOR | ● |

LEGENDA - LEGEND

- Di serie - Standard

Sistemi audio

Audio system



Big Bang \varnothing 55 x 55h

95



Scheda tecnica disponibile sul sito
www.gruppotes.it
 Technical drawing available on
www.gruppotes.it

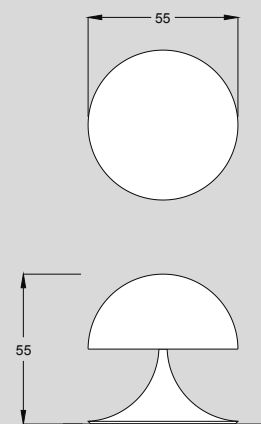

MODELLO MODEL	ARTICOLO ARTICLE	DESCRIZIONE DESCRIPTION	
	BB001	BIG BANG	2.400

DOTAZIONI SUPPLY	
• CASSA AUDIO BOSE / BOSE SOUND SYSTEM	●
• AMPLIFICATORE / AMPLIFIER	●
• BLUETOOTH / BLUETOOTH	●

LEGENDA - LEGEND

● **Di serie - Of series**

	OPTIONAL OPTIONALS	
CROMO3	CROMOTERAPIA CON FARETTI LED - CHROMOTERAPY WITH LED SPOTLIGHTS	650

Condizioni di vendita *Terms of sale*

Il presente listino annulla ogni precedente.

ORDINI Ogni ordine è impegnativo per il Committente, mentre ha valore di semplice proposta per la società Gruppo Tre S Spa che rimane, a sua volta impegnata con la sua conferma scritta di accettazione.

ANNULLAMENTO ORDINE L'ordine non può essere revocato dopo la conclusione del contratto, la società Gruppo Tre S Spa si riserva comunque di addebitare la spesa e gli oneri conseguenti.

ORDINE ERRATO Il materiale oggetto dell'ordine non può essere reso alla società Gruppo Tre S Spa se non dopo una sua accettazione scritta. Rimangono comunque a carico del Committente le spese di trasporto ed un importo pari al 25% del valore dell'ordine quale ordine di reimmagazzinaggio.

ORDINI SPECIALI L'ordine dei prodotti non a listino deve essere accompagnato da un acconto pari al 20% del valore del prodotto richiesto. Per tali prodotti la società Gruppo Tre S Spa non accetta alcun reso.

TERMINI DI CONSEGNA i termini di consegna sono puramente indicativi e non impegnativi.

PREZZI I prezzi di vendita sono quelli riportati sul listino vigente al momento della stipulazione del contratto e si intendono per forniture franco stabilimento di Nepi (VT) Italia. I prezzi sono indicati in Euro. Sono escluse, dal prezzo di vendita, tutte le spese e gli oneri accessori (trasporto, tasse, Iva, montaggi, ecc.) che rimangono a carico del Committente. La società Gruppo Tre S Spa si riserva la facoltà di variare i propri listini senza l'obbligo di preavviso. Tutti gli ordini ricevuti dopo l'avvenuta variazione, nonché tutte le spedizioni programmate oltre i 30 gg. dalla comunicazione di variazione, sono soggetti ai nuovi prezzi.

PAGAMENTI Le condizioni di pagamento, se non diversamente specificate e approvate dalla società Gruppo Tre S Spa, sono: a) Vendite nazionali: IVA a 30gg.: resto a seconda del credito concesso: b) Vendite all'estero: lettera di credito irrevocabile, confermata da una banca di primaria importanza. L'insorgere di qualsiasi controversia non esime il Committente dall'obbligo di pagare il prezzo pattuito secondo le condizioni convenute. Nessuna domanda o difesa può essere proposta in giudizio dal Committente qualora questi sia in mora con i pagamenti. Il ritardo, anche parziale del pagamento, genera la decorrenza degli interessi di mora calcolati nella misura del prime rate corrente aumentato di cinque (5) punti a far data dall'emissione della fattura.

RISERVA DI PROPRIETÀ La presente vendita è eseguita con riserva di proprietà (art. 1523 e seguenti C.C.), pertanto i prodotti rimangono di proprietà della società Gruppo Tre S Spa fino all'integrale pagamento del prezzo.

PROGETTAZIONE La società Gruppo Tre S Spa si riserva il diritto di cessare la produzione, senza preavviso, di qualsiasi modello e/o introdurre modifiche, senza per questo essere in obbligo di effettuare tali modifiche sui prodotti precedentemente forniti.

FATTURAZIONE MINIMA Qualsiasi ordine con importo inferiore a 500 EURO verrà regolarizzato con pagamento in contrassegno e verranno sempre addebitate euro 50 per spese di trasporto.

IMBALLO la merce viaggia in imballi in cartone compresi nel prezzo di vendita per trasporti via terra e su automezzi. Nessuno sconto è concesso per merce spedita o consegnata senza imballo, imballi diversi verranno fatturati al costo.

TRASPORTO La merce, che viaggia a rischio e pericolo del Committente, viene resa franco stabilimento di Nepi. Non vengono accettati indirizzi diversi dalla sede commerciale del cliente. La bolla di accompagnamento firmata al momento dello scarico vale come dichiarazione di esatta corrispondenza di quanto in essa elencato. I reclami saranno accettati solo se verranno inoltrati entro 2 giorni dalla data di consegna a mezzo raccomandata con ricevuta di ritorno.

RESI I resi di materiale devono essere preventivamente autorizzati dalla società Gruppo Tre S Spa a condizioni che si tratti di prodotti nuovi, mai usati e di modelli ancora in produzione presso la società Gruppo Tre S Spa e che i medesimi non siano stati consegnati da più di 12 mesi. I prodotti non a listino (speciali, consegnati su specifica richiesta del Committente) non possono essere restituiti. Le spese di trasporto sono a carico del Committente sul quale graverà l'onere di reimmagazzinaggio pari al 25% del valore del materiale reso alla data dell'acquisto.

GARANZIA Tutti i prodotti del Gruppo Tre S, secondo quanto stabilito dal Codice del Consumo, sono coperti da una garanzia convenzionale di 2 anni (1 anno nel caso di acquisti professionali). Nel caso di richiesta di interventi in garanzia sui prodotti tenuti a stock o in esposizione presso sale mostra, che abbiano superato i 24 mesi dalla consegna o che comunque siano stati prodotti da più di 36 mesi (vedi etichetta di produzione all'interno della garanzia), non è previsto diritto ad intervenire in garanzia se non in seguito ad accordo specifico tra le parti. La garanzia è valida solo per prodotti acquistati ed installati nel territorio italiano Vedi condizioni e certificato di garanzia allegato al prodotto per tutto quanto non espressamente specificato.

FORO COMPETENTE Per qualsiasi controversia è esclusivamente competente il Foro di Roma applicabile anche in deroga alle norme dei Paesi esteri la legislazione Italiana. Permane la competenza del Foro di Roma anche se il pagamento sia pattuito a mezzo effetti cambiari. Il committente dichiara di ben conoscere ed accettare tutte le condizioni di vendita sopra elencate ed in particolare accetta e conferma ai sensi dell' art. 1341 C.C. la garanzia e le seguenti clausole: Ordini, Annullamento ordine, Ordine errato, Ordini speciali, Termini di consegna, Prezzi, Pagamenti, Riserva di proprietà, Progettazione, Fatturazione minima, Imballo, Trasporto, Resi.

This price-list annuls all previous ones.

ORDERS Every order is binding for the Purchaser, while it has the value of proposal for Gruppo Tre S Spa who is in turn committed by its written confirmation of acceptance.

ORDER CANCELLING An order cannot be revoked after the execution of the contract. At events, Gruppo Tre S Spa reserves to charge any consequent expenses and costs.

MISTAKEN ORDER Material ordered cannot be returned to Gruppo Tre S Spa except after written acceptance. The Purchaser will be charged with transport expenses and 25% of the value of the order for coverage of re-storage fees.

SPECIAL ORDERS An order for products not included in the price-list must be accompanied by a down payment of 20% of the value of the product requested. Gruppo Tre S Spa accepts no returns for these products.

TERMS OF DELIVERY The terms of delivery are indicative only and not binding.

PRICES The sale prices are those given in the current price-list at the time of execution of the contract and are for ex Nepi works (VT) Italy supplies. Prices are indicated. The sale price does not include any expenses and charges (transport, tax, vat, assembly, etc.) which are at the customer's expense. Gruppo Tre S reserves the faculty to change its price-list without prior notice. All orders received after a change, and all shipments scheduled over 30 days from the notice of a change, are subject to the new prices.

PAYMENTS If not otherwise specified and approved by Gruppo Tre S Spa, the terms of payment are the following:

A) National sales: VAT 30 days; remainder according to the granted credit.

B) Foreign sales: irrevocable letter of credit confirmed by a leading bank.

Any dispute will not exempt the Purchaser from settling the agreed price according to the agreed terms. The Customer may not start legal proceedings if in arrears with payments. Any delay, even partial, will cause interest on delayed payment calculated on the amount of the first current instalments increased by five (5) points as from the date of issue of the invoice.

CONDITIONAL SALE This is a conditional sale (art.1523 and following of the Civil Code), therefore, the products remain the property of Gruppo Tre S Spa until the price has been paid in full.

DESIGN Gruppo Tre S Spa reserves the right to cease the production of any model and/or bring about changes without prior notice and without being obliged to make such changes on products supplied previously.

MINIMUM INVOICE AMOUNT Any amount under 500,00 must be paid upon delivery.

PACKING Goods travel in cardboard packaging which is included in the cost of land transport. No discount is given for goods dispatched or delivered without packaging. Other packaging will be invoiced at cost.

TRANSPORT The goods travel at the Purchaser's risk and peril on an ex Nepi works basis. Addresses other than the purchaser's business address are not accepted. The delivery note signed at the time of unloading is valid as certification that the goods correspond exactly to the items listed on it. Claims will only be accepted if they are forwarded within 2 days of the date of delivery by registered mail with notice of receipt.

RETURNS Returns of material must be authorized beforehand by Gruppo Tre S Spa, provided that they are new products which have never been used and models still being manufactured by Gruppo Tre S Spa and that were not delivered over 12 months before. Products not included in the price-list (special products, delivered against specific Purchaser's request) may not be returned. Transport expenses are to be paid by the Customer in addition to a re-storage fee amounting to 25% of the value of the returned material at the date of purchase.

GUARANTEE All Gruppo Tre S products are covered by a 2-year warranty (1 year for professional purchases), in accordance with the dispositions of the Consumer Code. Requests for replacements/repairs under warranty, in relation to products in stock or exhibited in show rooms, over 24 months from their delivery or, in any case, over 36 months from their production date (see production label in the warranty), will not be accepted, unless the parties have specifically agreed otherwise. The warranty is valid only for products bought and installed in Italy.

For any matters not expressly specified, please see the conditions and warranty issued with the product.

COURT OF JURISDICTION For any dispute, the only court of jurisdiction is the Court of Roma according to Italian law not with standing the provisions of the laws of foreign countries. The court of jurisdiction is still Roma even if payment has been arranged by bills of exchange. The purchaser declares to be well aware of and to accept all the terms of sale listed above and in particular he accepts and confirms the guarantee and the following clauses as per art. 1341 of the Civil Code: Orders, Order cancelling, Mistaken order, Special orders, Terms of delivery, Prices, Payments, Conditional sale, Design, Minimum billing, Transport, Returns.

treesse
www.gruppotreesse.it



GRUPPO TRE S.p.a.

Sede legale - Registered office
Via Cassia, 698
00189 Roma (RM) Italia

Sede operativa - Operational headquarters
Via degli Imprenditori, 8-10
Zona industriale Settevene
01036 Nepi (VT) Italia
Tel. (+39) 0761 527242
Fax (+39) 0761 1765419
info@gruppotres.it

