

RELAX SOLUTIONS



STARPOOL

wellness concept

Welcome to
a new dimension
of Wellness



Summary

Relax Solutions	9
<hr/>	
STARLONGUE	
Functional design	14
Data sheet	16
<hr/>	
STARLIT	
Functional design	22
Data sheet	24
<hr/>	
DAYBED	
Functional design	30
Data sheet	32
<hr/>	
BRIDGE LOUNGER	
Functional design	38
Data sheet	40

SYNUA LOUNGER	
Functional design	46
Data sheet	48
<hr/>	
SWEETCHAIR	
Functional design	54
Data sheet	56
<hr/>	
CLASSIC HEATED CHAIR	
Functional design	62
Data sheet	64
<hr/>	
VALUABLE RELAXATION	
Wellness Coach	69
Salt Wall	71
<hr/>	
Covering Materials Table	74

We combined ergonomic shapes, aesthetics and nature-inspired materials to make them live together in our products dedicated to rest. Shapes that follow the lines of the body, turning relaxation into a moment of absolute well-being.

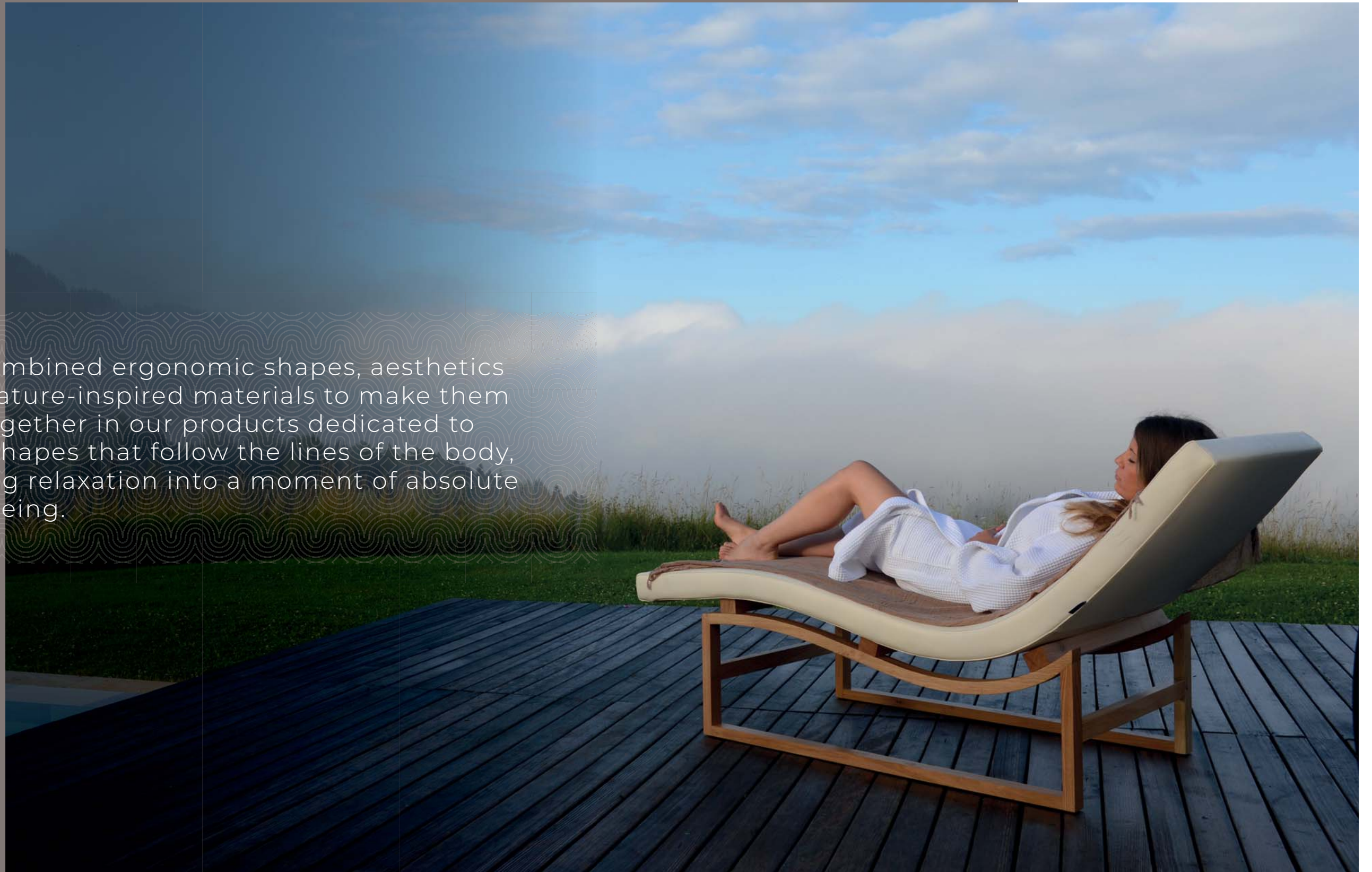



Relax Solutions

*Essential moments of rest
for body and mind*

Both body and mind are at peace in a comfortable
and serene environment.

A must for every wellness program, rest is the condition in which
the body is relaxed and enjoys positive sensations **to experience**
in a comfortable, peaceful and welcoming environment.

Our wellness formula, which is based on the alternation between
heat, water and rest, identifies this phase as the perfect ending
of every Wellness experience. It is an essential moment for the
body to recover its energy and restore its physiological balance
after the alternation of hot and cold temperatures.

It is for this reason that we **design relaxation areas**
with the utmost care and dedication.



Starlongue

Design by Studio Bizzarro & Partners

For a soft and embracing rest



STARLONGUE

Starlongue

ERGONOMICS AND COMFORT

A chaise longue for resting, reading, meditating.

The **sinuous and linear shape** of Starlongue supports the body perfectly, welcoming it in a soft embrace.

Ergonomic, compact and light, it is the ideal solution to transform rest in a moment of absolute well-being. Its design is enriched by style details that make it basic and sophisticated at the same time, so that it blends perfectly in any environment.



Functional design

The design by Starpool is the right balance between taste and function. We aim to create products that can blend in any environment, thanks to the wide range of available fabrics and colours.



SINUOUS SHAPE

The ergonomic shape of Starlongue allows the body to adhere perfectly to the structure: legs remain in an elevated position and the knees rest slightly above the heart, favouring venous circulation.

ANTI-SLIP FEET

The structure is supported by four invisible anti-slip feet, which ensure perfect stability.



HIGH-QUALITY SEAMS AND FABRIC

The precious finishes, featuring visible stitching that highlights its outline, ensure the stability and resistance of the fabric. The quality of the covering materials contributes to the product high performance standards.



LIGHT AND EASY TO TRANSPORT

Robust and stable, it is also very light thanks to the wooden structure. The padding is in high-density rigid polyurethane foam covered with polyester wadding.

Data Sheet

Dimensions (cm)	190 w x 70 d x 70 - 32 h
Structure	Plywood with anti-slip feet (2-cm h)
Seat	High-density rigid polyurethane foam covered with polyester wadding
Weight	26 Kg
Use	Indoor

See all covering materials on page 74.

Layout

Plan



Side view

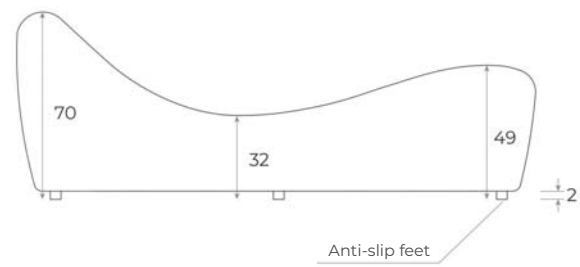

Perspective drawing

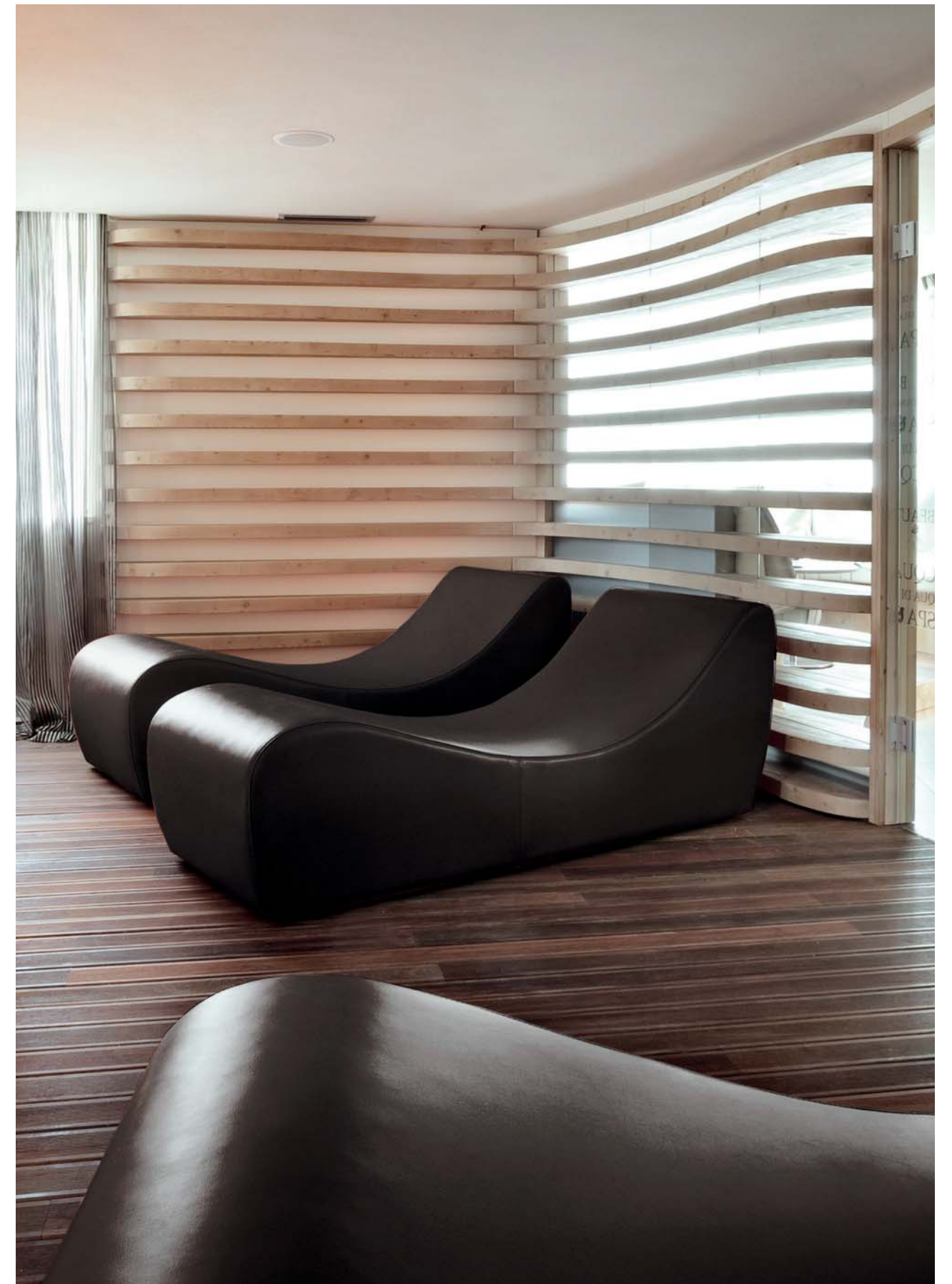
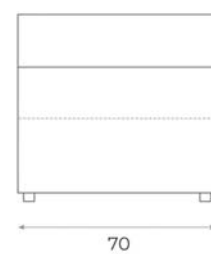



Starlit

Design by Baldessari e Baldessari

The perfect encounter between history and design



STARLIT

Starlit

PURE ELEGANCE

Inspired by the classic "dormeuses" that furnished the bedrooms and sitting rooms of the noble seventeenth-century residences, Starlit reinterprets that **simple and comfortable design** from a modern perspective.

Starlit is robust, stable and cosy and its design is characterised by sinuous and elegant lines, as well as a versatile style. The central structure is covered with a soft padding that embraces the guest, ensuring moments of deep rest.



Functional design

The design by Starpool is the right balance between taste and function.

We aim to create products that can blend in any environment, thanks to the wide range of available fabrics and colours.



SPACE-SAVING CYLINDER

Aesthetics and function co-exist in the two decorative cylinders containing the cushions and which, at the same time, become space-saving compartments for flip-flops, bags and towels.



ELEGANT MARQUETRY

The structure of the side pillars is in olive wood, the shape of its own leaves masterfully carved. Olive wood is very hard and has a nearly golden colour, with intense brown streaks. It is compact and homogeneous, resistant to wood worms and ideal for the manufacturing of fine furniture.



COMFORTABLE PADDING AND COVERING

The padding in polyurethane foam with visible stitching ensures both comfort and resistance of the fabric.



HEADREST AND LEG REST

The two provided bolsters have different dimensions, and support the cervical area and the legs for the maximum possible comfort.

Data Sheet

Dimensions (cm)	206 w x 65 d x 48 - 40 h
Structure	Plywood with steel feet (1-cm h)
Cylinder	Bent plywood with a 45-cm diameter, 19-mm thickness, veneered on both sides with olive wood.
Seat	High-density rigid polyurethane foam covered with polyester wadding
Weight	44 Kg
Use	Indoor

Provided accessories: head bolster / leg bolster
See all covering materials on page 74

Layout

Plan



Side view

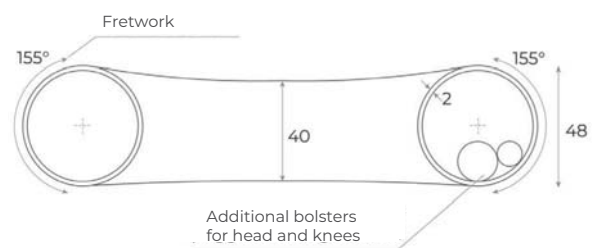

Perspective drawing

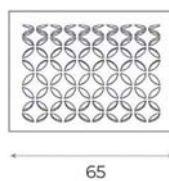



Daybed

Design by Cipiuelle Architecture and Interior Design
In between living and bedding



DAYBED

Daybed

REGENERATING REST

The simplicity of Daybed is highlighted by the minimal design that characterises the **adjustable backrest** and the robust structure in oak wood.

A timeless identity, characterised by round corners, soft padding, and **neat lines** that follow and support the body, during the moments of regenerating rest. This seat is the perfect example of how living and bedding can coexist in one object.



Functional design

The design by Starpool is the right balance between taste and function. We aim to create products that can blend in any environment, thanks to the wide range of available fabrics and colours.



ADJUSTABLE BACKREST

The raised backrest is perfect for relaxing during the day, while when it is completely lowered, this chaise longue can be used as an actual bed.

OAKWOOD STRUCTURE

The base in oak wood lends natural inspiration to Daybed. The varnished base and the feet under the chaise longue allow to place it even in wet environments, like by the poolside. The rear casters make it easy to move and protect the flooring as well.

SHELF TOP

The wooden panel placed under the backrest allows to optimise the available space by offering a functional support to range personal belongings.

COMFORT AND ATTENTION TO DETAIL

Round corners, soft padding, and stitching that divides the backrest and the seat, thus preventing the formation of uncomfortable folds when the backrest is raised.

Technical data

Dimensions (cm)	200 w x 80 d x 80 - 33.5 h	
Structure	In natural oak wood or thermowood oak	
Base	 Thermowood Oak  Natural Oak	Surface top in marine-grade plywood veneered in oak coated with weather-resistant varnish, steel front feet, back casters to move the seat
Seat	High-density rigid polyurethane foam covered with polyester wadding	
Weight	59 Kg	
Use	Indoor	

Extra: topper

See all covering materials on page 74.

Layout

Plan



Side view

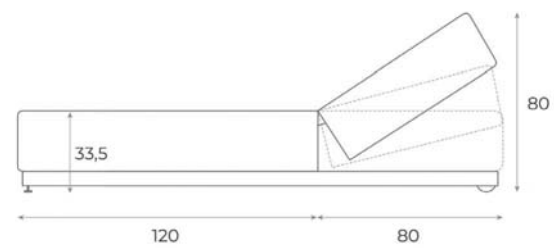

Perspective drawing

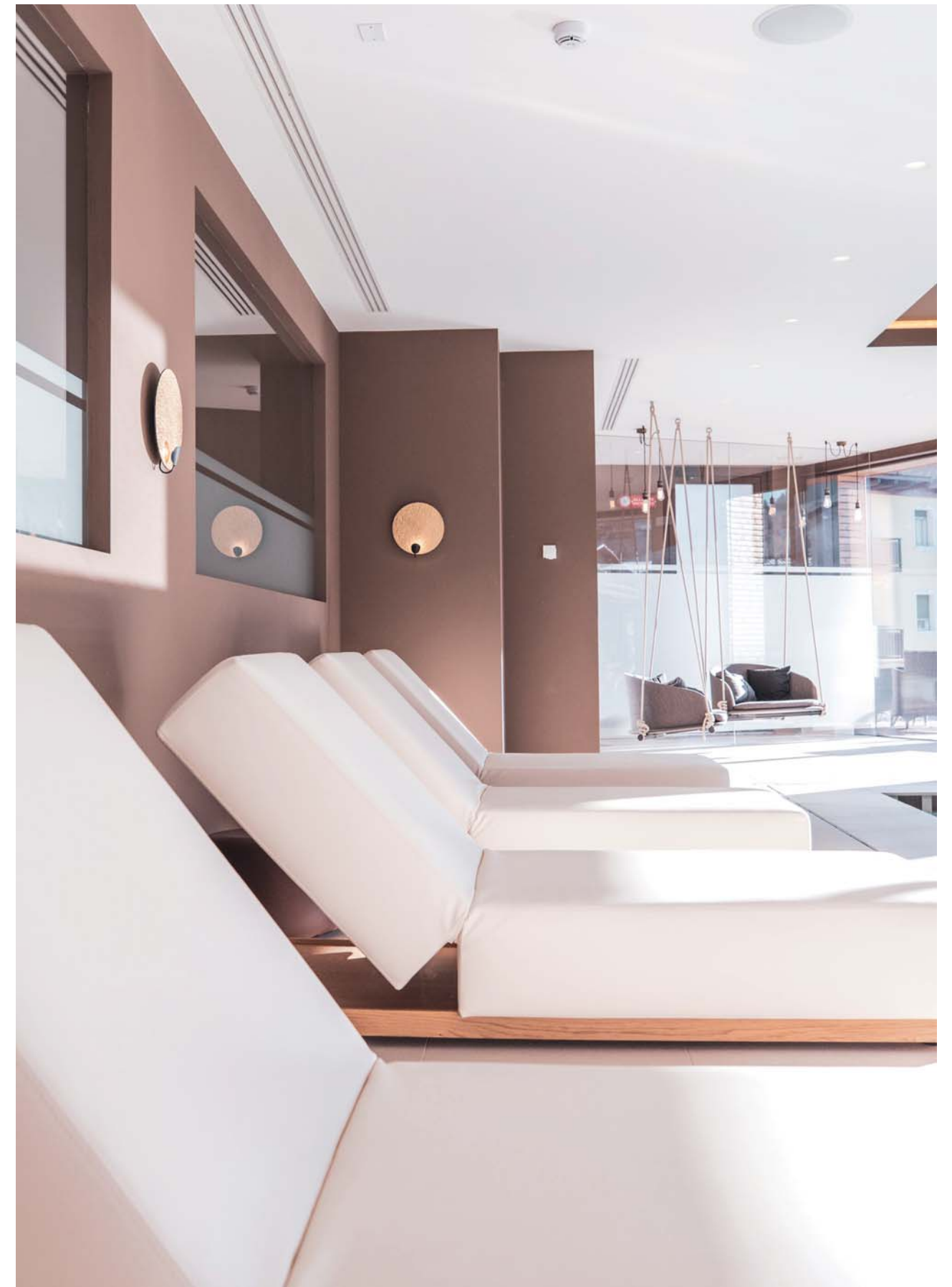
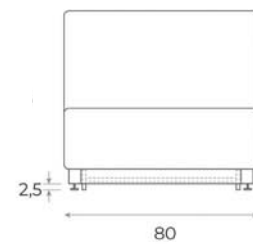



Bridge Lounger

Design by Luca Scacchetti

Essential purity of shapes



BRIDGE LOUNGER

Bridge Lounger

THIN SHAPES

Sinuous and elegant, Bridge Lounger is the way to a profound and calm rest.

The essential lines and the **minimal design** convey lightness and simplicity through harmonious proportions. The **ergonomic profile** embraces the body, transforming rest in a moment of true well-being. Stable and resistant, it adapts to every indoor environment as a sophisticated décor item.



Functional design

The design by Starpool is the right balance between taste and function.
We aim to create products that can blend in any environment,
thanks to the wide range of available fabrics and colours.



SHEER SIMPLICITY

The softness of the seat, in contrast with the neat lines of the base in oakwood, results in a minimal and elegant kind of design that conveys harmony in its proportions.

RESISTANCE AND STABILITY

The joints are robust and ensure utmost stability and resistance.



LIGHTNESS AND COMFORT

A thin but comfortable mattress ensures top comfort. Bridge Lounger is light and easy to transport.



SUITED FOR EVERY AREA

Extremely versatile, Bridge Lounger is ideal for any environment: spa areas, wellness centres, pools, home spaces. It is also perfect as a décor item for living or night areas.

Data Sheet

Dimensions (cm)	165 w x 72 d x 85 - 37 h	
Structure	Bent plywood	
Base	 	Natural solid oakwood with weather-resistant varnish
Seat	High-density polyurethane foam covered with polyester wadding	
Weight	35 Kg	
Use	Indoor	

See all covering materials on page 74.

Layout

Plan

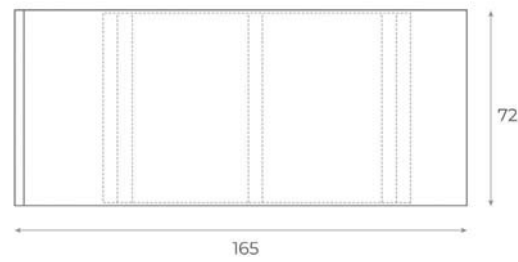

Side view

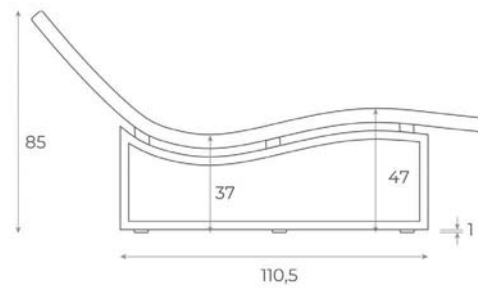

Perspective drawing

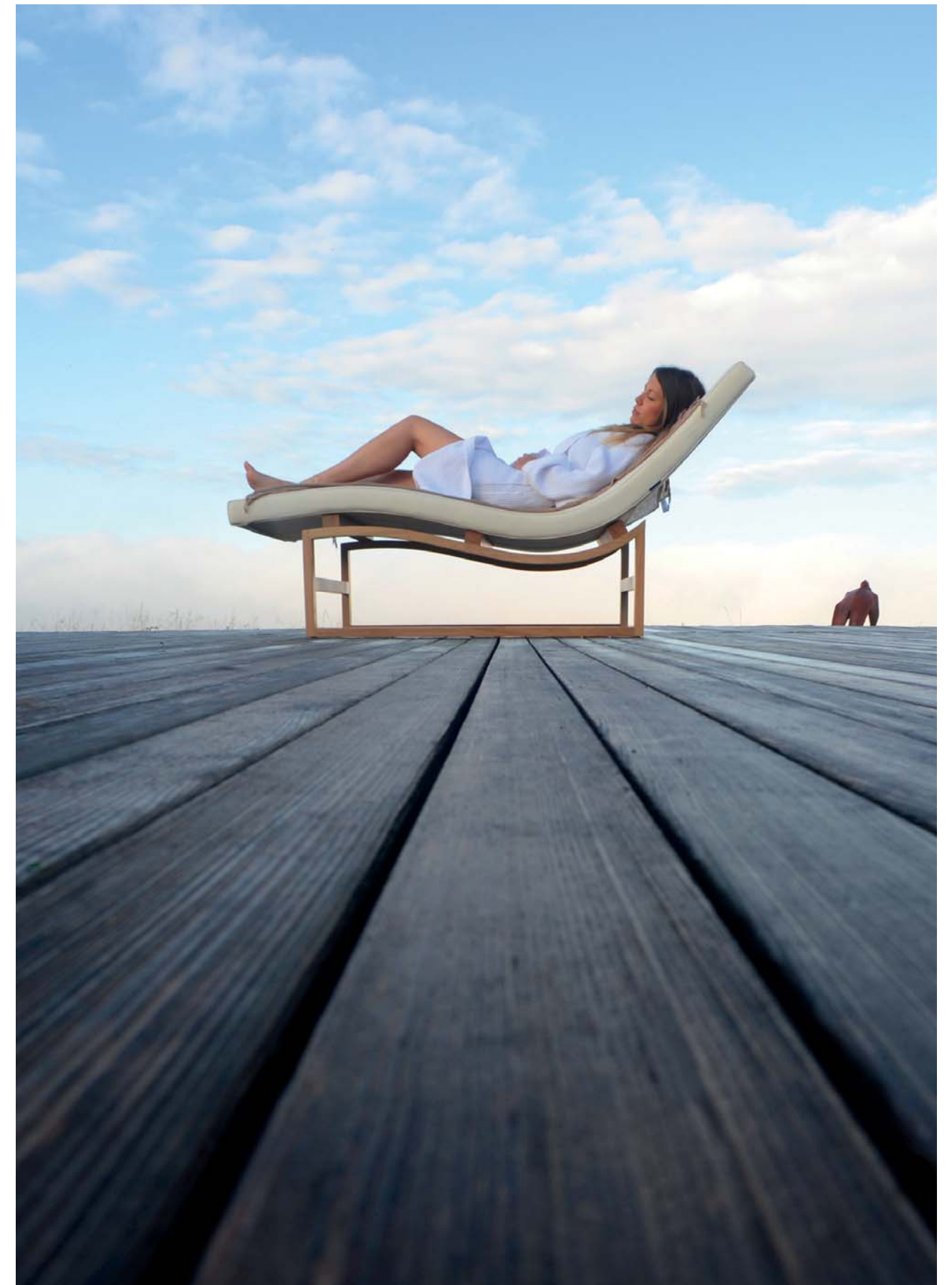



Synua Lounger

Design by Cipiuelle Architecture and Interior Design

The absolute comfort of sinuous lines



SYNUA LOUNGER

Synua Lounger

A SINUOUS WELCOME

Synua is designed for maximum relaxation: its **harmonious proportions** outline the sinuous shape, which perfectly supports and embraces the body, thus ensuring utmost comfort.

The **sophisticated design** has a definite identity, highlighted by the structure in oakwood. The supplied soft headrest cushion was designed precisely to improve posture while resting.

The quality is also evident in the choice of the **fine materials** for the padding of the central structure, which make this chaise longue the perfect place to abandon yourself to absolute peace.



Functional design

The design by Starpool is the right balance between taste and function.
We aim to create products that can blend in any environment,
thanks to the wide range of available fabrics and colours.

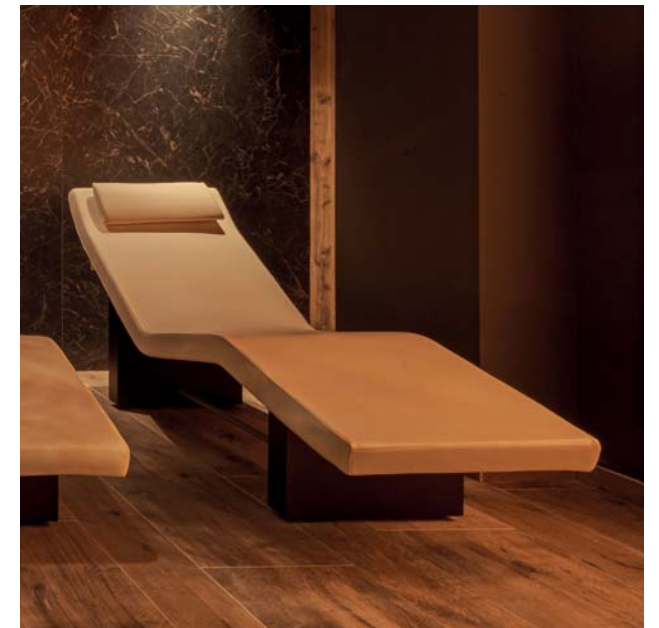
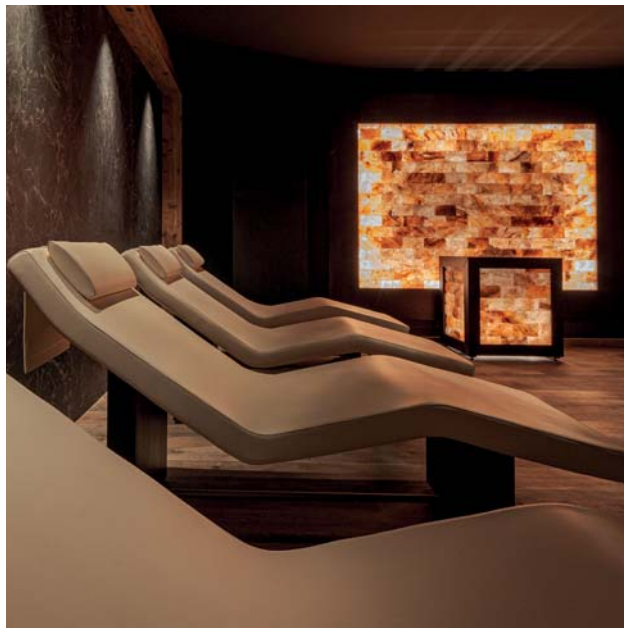

PERFECTLY ERGONOMIC

The sinuous and ergonomic shape allows the body to adhere perfectly to the seat, ensuring the best of comfort.

STRUCTURE IN OAK AND ALUMINIUM

This simple and elegant structure is in Natural Oak or Thermowood Oak. It is supported by a polished-aluminium bar which lends the chaise longue a bold appearance.

HEADREST

The headrest cushion is adjustable according to one's height.

COMFORTABLE PADDING AND COVERING

Soft padding in high-density rigid polyurethane foam covered with polyester wadding.

Data Sheet

Dimensions (cm)	180 w x 63 d x 90 - 42 h	
Structure	Plywood	
Base	 	Plywood veneered with natural or thermowood oak coated with weather-resistant varnish, aluminium support bar
Seat	High-density polyurethane foam covered with polyester wadding	
Weight	40 Kg	
Use	Indoor	

Provided accessories: height-adjustable head cushion

See all covering materials on page 74.

Layout

Plan

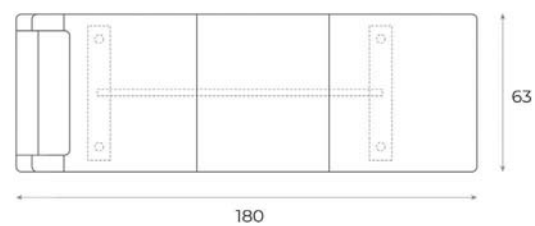

Side view

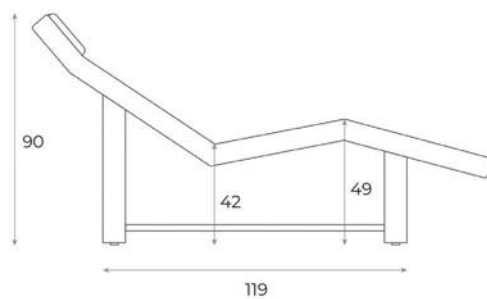

Perspective drawing

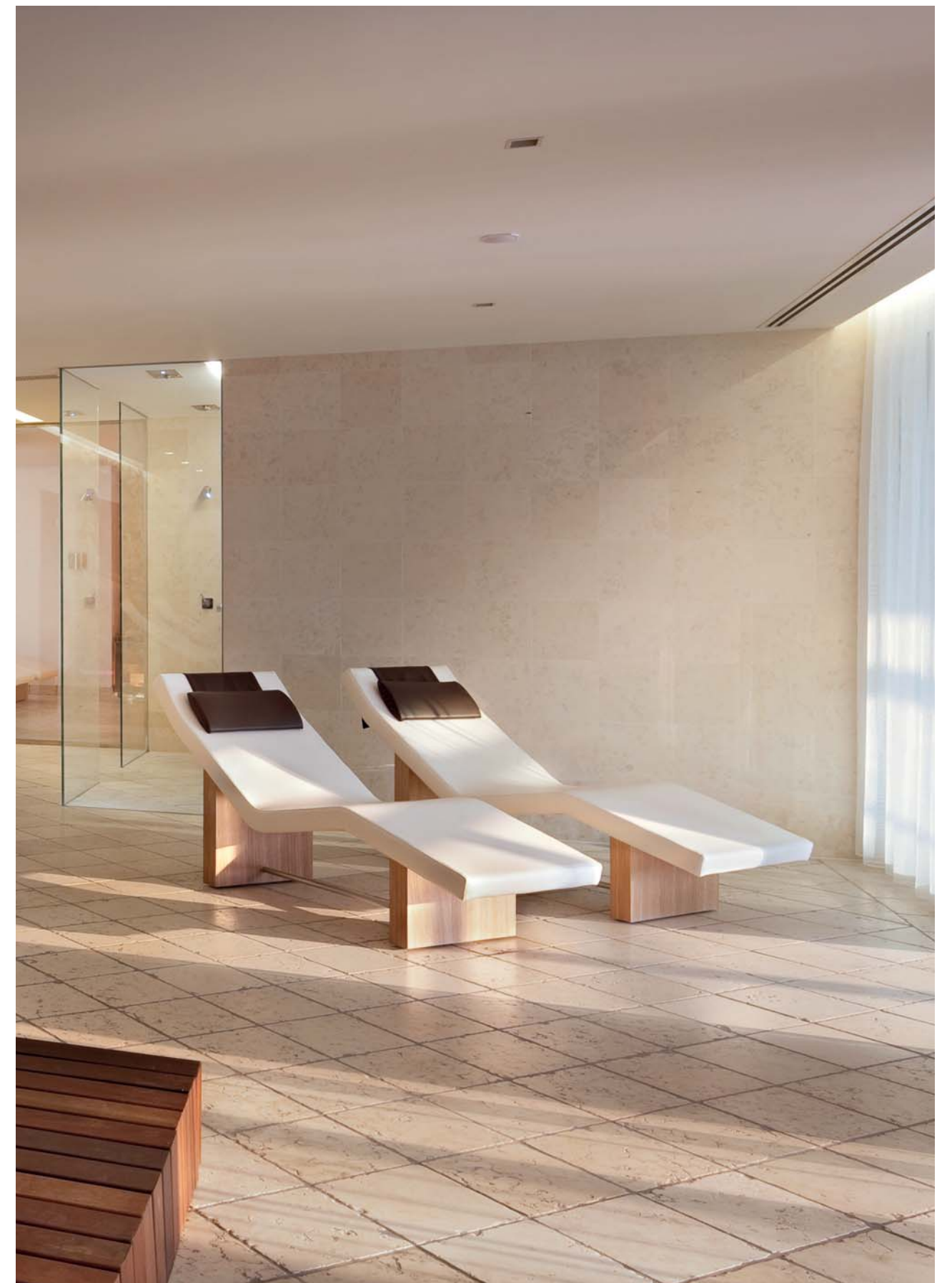
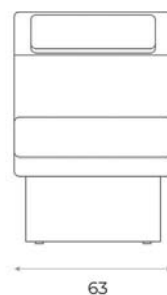



Sweetchair

Design by Fabio Alemanno

Design and technology
for unforgettable relaxation



SWEETCHAIR

Sweetchair

REST OF MARBLE

SweetChair embodies both design and technology.

Its **ergonomic shape and high versatility** make it the ideal choice for both professional and home environments.

The completely adjustable backrest, the soft headrest cushion and the top in heated marble make every moment dedicated to rest exceptionally comfortable.



Functional design

The design by Starpool is the right balance between taste and function. We aim to create products that can blend in any environment, thanks to the wide range of available fabrics and colours.



EMBRACING WARMTH

Sweetchair is equipped with an infra-red system that radiates the heat on the whole stone surface. The digital thermostat allows for the regulation of the temperature up to 41.5 °C, turning the smooth and soft marble surface in an alcove of perfect relaxation.

WATERPROOF STRUCTURE

Thanks to the waterproof structure, Sweetchair can also be installed outdoor or in environments that are especially wet. The rear casters make it easy to move and protect the flooring as well.

LEATHER HEADREST

The soft leather headrest makes Sweetchair the ideal daybed to abandon oneself to warm and comfortable relaxation.

RECLINE BUTTONS

The automatic and full regulation of the backrest inclination allows everyone to choose their ideal position to rest or to read (this feature is an extra).

Data Sheet

Dimensions (cm)	193 w x 68 d x 83.5 - 42 h
Structure	Anti-rust steel
Structure cladding	Water-resistant fibreglass with metal black varnish
Seat	Marble single slab
Weight	190 Kg
Temperature	Up to 41.5 °C with infrared heat radiation system
Default heated surface	Total surface heated through one sensor
Necessary connections for installation	16A Schuko socket
Energy consumption to heat the bed	220-240V/800W - 110-120V/950W
Digital thermostat	For temperature regulation up to 41.5 °C
Use	Indoor / outdoor

Models



Lime Stone
Cod. 601



Nero Marquinia
Cod. 602



Calacatta
Cod. 603



Eramosa
Cod. 604

As an extra: recline buttons for the automatic and full regulation of the backrest inclination.
Headrest cushion included.

Layout

Plan

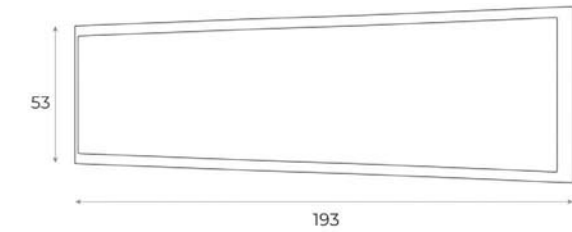

Side view

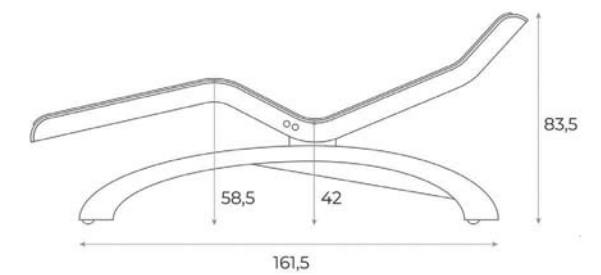

Perspective drawing

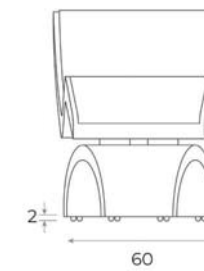



Classic Heated Chair

The contemporary charm
of the ancient Roman baths



CLASSIC HEATED CHAIR

Classic Heated Chair

WARM REST

We reinterpreted the style and charm of the ancient Roman baths from a modern perspective, creating a **relaxation bed** for deep mental and physical relaxation.

This seat evokes the *“tepidarium”*, the warm and cosy environment of the ancient baths, where the **heat is radiated to the body.**

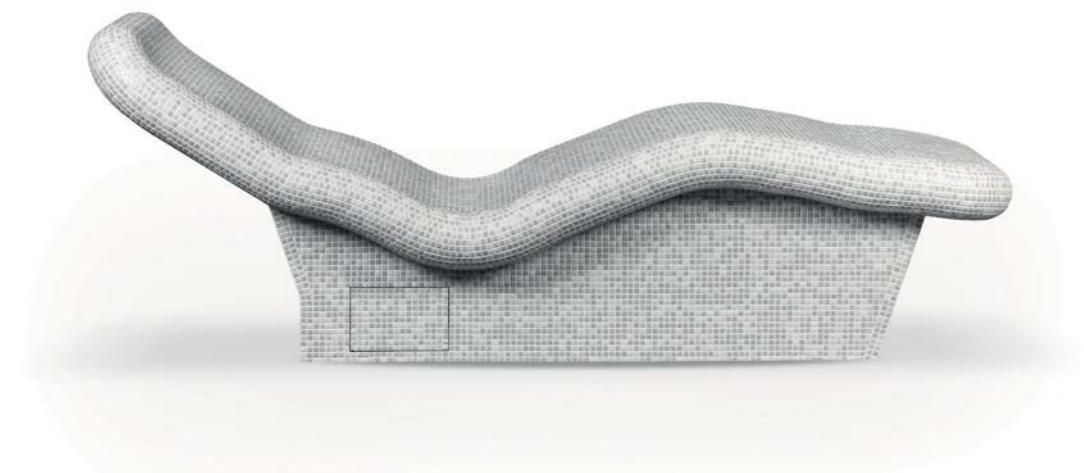

Functional design

The design by Starpool is the right balance between taste and function. We aim to create products that can blend in any environment, thanks to the wide range of available fabrics and colours.



ERGONOMIC DESIGN

This seat is designed to favour appropriate blood flow and offer complete comfort.

EMBRACING WARMTH

34 /39 ° C

This kind of heat transmission has significant benefits and is recommended before and after every wellness program. Before the experience, it prepares the body to endure the high temperatures of sauna and steam bath, while after it, it helps to maintain the right body temperature and favours full relaxation.

HEADREST

It is possible to add the comfortable height-adjustable headrest to improve the posture during the rest phase.

AESTHETICS AND EXTRAS

The product can be chosen unfinished or clad with different available types of mosaic.

Data Sheet

Dimensions (cm)	185 w x 70 d x 70 h
Structure	In high-density EPS, with or without cladding
Cladding	Mosaic
Seat	High-density polyurethane foam covered with polyester wadding
Weight	80 kg
Temperature	34/39 °C through heat radiation system
Voltage and consumption	Power supply line 1P+N - 220/240V - 1000W
Use	Indoor

Layout

Plan

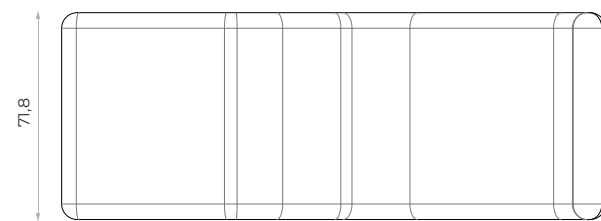

Side view

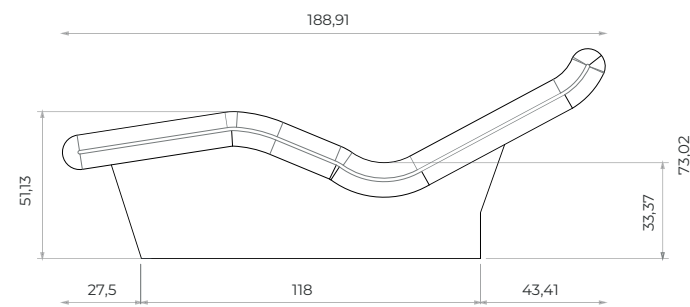

Perspective drawing

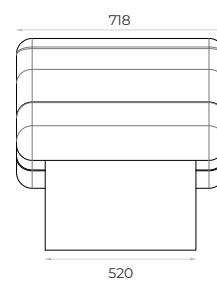

A modern relaxation room with a glowing stone wall, a wicker chair, and a STARPOOL salt lamp. The room has a wooden floor and white curtains. The stone wall is made of large, irregular, glowing stones in shades of yellow and orange. The wicker chair is made of dark brown wicker and has a dark brown cushion. The STARPOOL salt lamp is a square-shaped lamp with a metal frame and a glowing stone front panel. It has a small label that says "STARPOOL" on the top edge. The lamp is sitting on a wooden floor. The glowing stone wall is in the background, and the wicker chair is in the foreground. The room is dimly lit, with the main light source being the glowing stone wall and the STARPOOL salt lamp. The overall atmosphere is warm and relaxing.

Valuable relaxation

In every type of relaxation area in spas, as well as in every space dedicated to regeneration and recovery, we develop products to theme rest, turning it into a moment of deep well-being.



VALUABLE RELAXATION

Wellness Coach

MENTAL WELLNESS WITH ONE CLICK

Wellness Coach is the virtual guide for the well-being of body and mind. An interactive system to feel good and fit, through the Brain Training contents developed in collaboration with renowned partners from the fields of research and sports. With Wellness Coach, the moments dedicated to rest are transformed in actual **experiences of psycho-physical regeneration**, thanks to Mindfulness and guided breathing programs developed to favour actual mental training.

The **Personal model**, equipped with noise-cancelling headphones, was developed to boost individual moments of rest.

The **Social model**, equipped with a high-quality Bluetooth loudspeaker, is the ideal solution for immersive experiences even in shared environments. The software allows to plan Brain Training events, with Mindfulness and guided breathing programs, to meet the needs of guests who are more and more attentive to mental health.

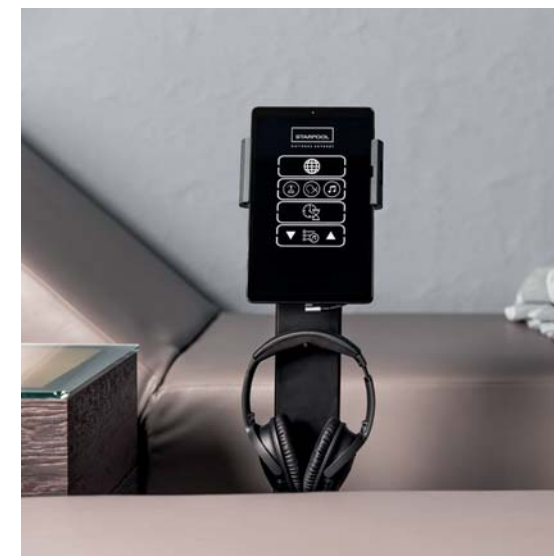

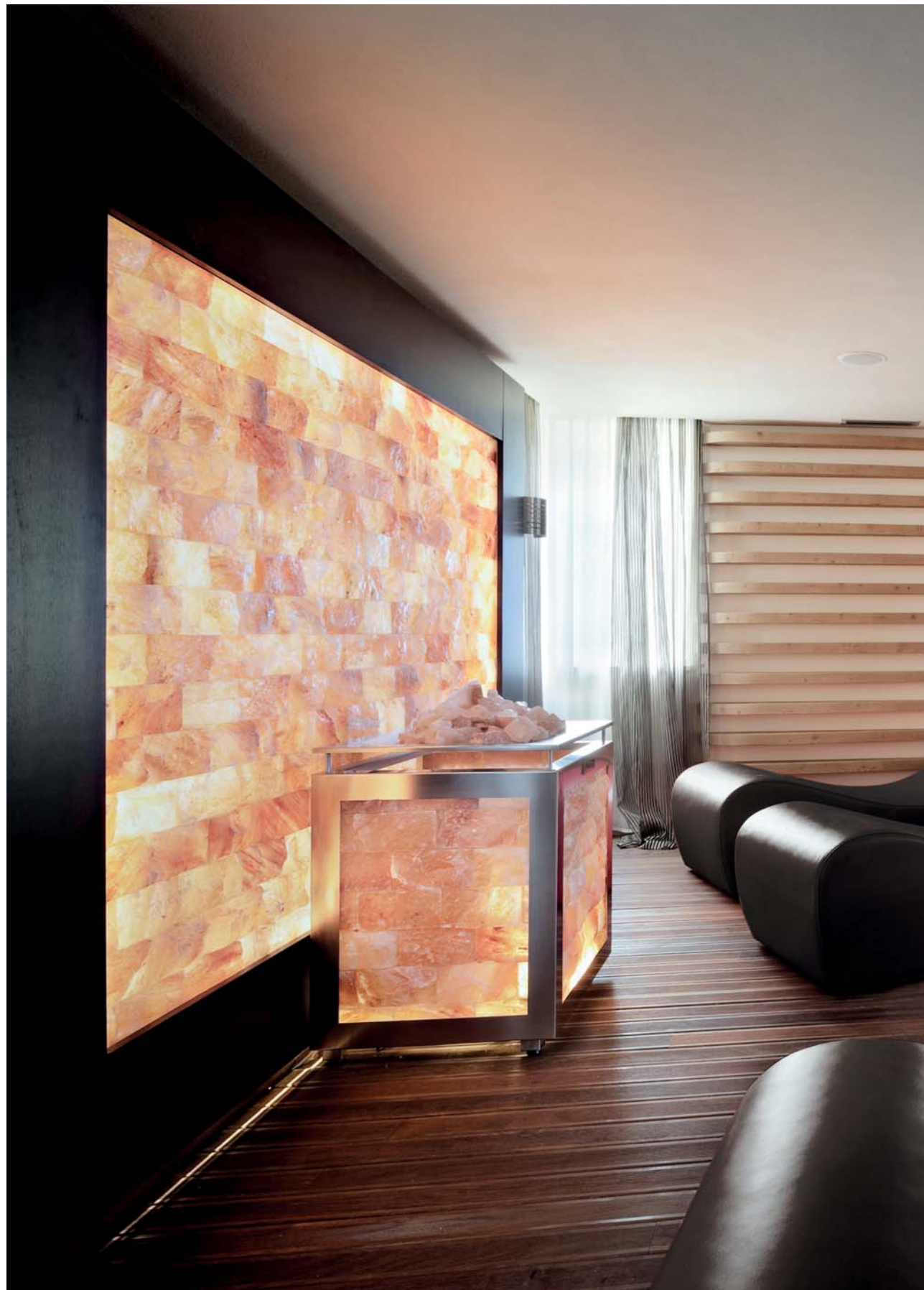

VALUABLE RELAXATION

Salt Wall

RELAXING NATURAL THERAPY

Salt Wall **combines the positive effects of mineral salt with the relaxing power of light.**

In the relaxation area, heat and humidity are maintained at a constant level thanks to **a stove that regulates the parameters** inside the room.

The process of salt ionisation helps create optimum conditions that add value to the moment devoted to rest, offering a peaceful **sensation of calm.**













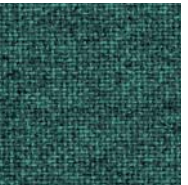

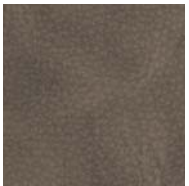

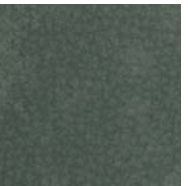

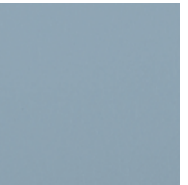

The clean and dry air helps to strengthen the immune system. It improves respiratory function, favours blood flow and regulates blood pressure.

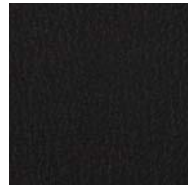
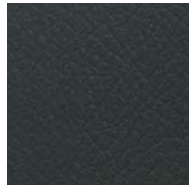



Covering

Covering Materials Table

Fabric	2505 Beige	1999 Light Grey	1556 Light Brown	1495 Dark Green	1620 Dark Grey
					
Vintage Eco-Leather	01 Sandy	03 Nut Brown	04 Umber	05 Olive	09 Dark Brown
					
Sky Eco-Leather	EZ5 Forest Green	HA4 Navy Blue	G78 Dark Blue	GB5 Azure	FD5 Dove Grey
					
	F84 Chocolate Brown	BE4 Smoke Grey	CD5 Green Apple	B99 Black	D18 Creamy White
					
Real Leather	2436 Olive Green	2433 Warm Grey	2434 Caramel	2404 Terracotta Brown	2402 Black
					

The covering materials are not available for Classic Heated Chair and Sweetchair.

NB: The colours of the fabrics shown here serve purely as an indication, as they are subject to printed colour change. For an accurate idea of the texture and colour types, we recommend consulting the Textile Samples Book.



wellness concept

Via Stazione 25 · 38030 Ziano di Fiemme (TN) · Italy
+39 0462 571 881 · info@starpool.com
starpool.com