

SECTION A-A  
SCALE 1:5

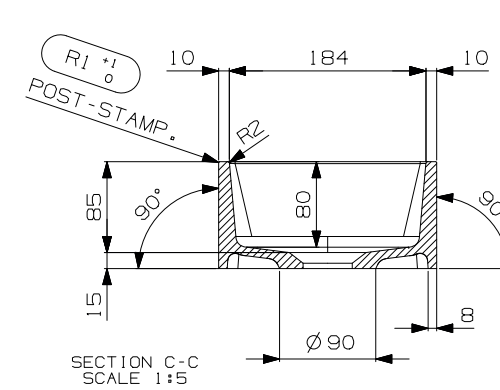

SECTION C-C  
SCALE 1:5

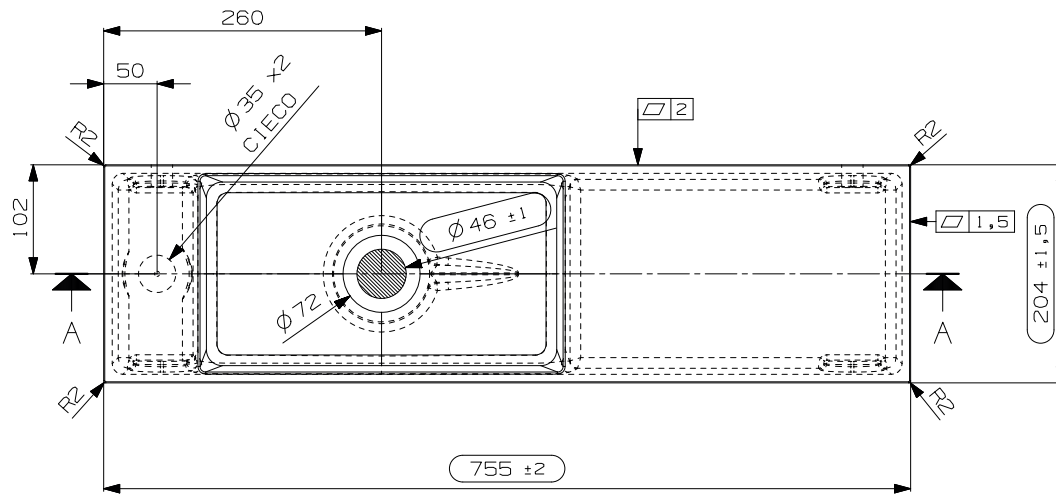

SCALE 1:5

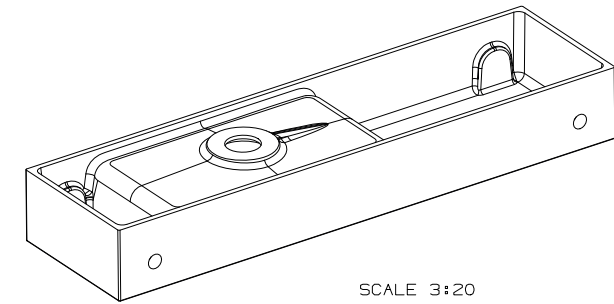

SCALE 3:20

N° DATA/Date	FIRMA/drawn by	DESCRIZIONE REVISIONE/Revision description
1		

NOTE/Notes		N° STAMPO/Mould Number
.....		C01536A
VEDI SCHEDE ALLEGATE		Prog. 24-049
.....		PESO NETTO/Weight
.....		Kg. 7
.....		DATA REV.0/Date Rev.0
.....		15/01/2025
CLIENTE/Client	MODELLO/Model	EMESSO/Drawn by
NICOS INT.	JOY	FABRIZIO D.
DENOMINAZIONE/Product Name		VERIFICATO/Checked by
LAVAMANI 75		A. MANIAGO