

Essentials

Showroom Proposals

alpi

Essentials

Contents

- Espositori da sala mostra - Showroom displays
- Prodotti su bassetta espositiva - Products on display base
- Box campionari - Samples boxes
- Mini Groove
- Finiture - Finishes display
- Logo

Espositori da sala mostra - Showroom displays



Espositori da sala mostra - Showroom displays

A EXPO ORIZZONTALE - HORIZONTAL DISPLAY

code ESP026

Banchetto espositivo con piano reversibile per posizionamento prodotti con o senza basetta.

display stand with reversible counter top for positioning products with or without base.

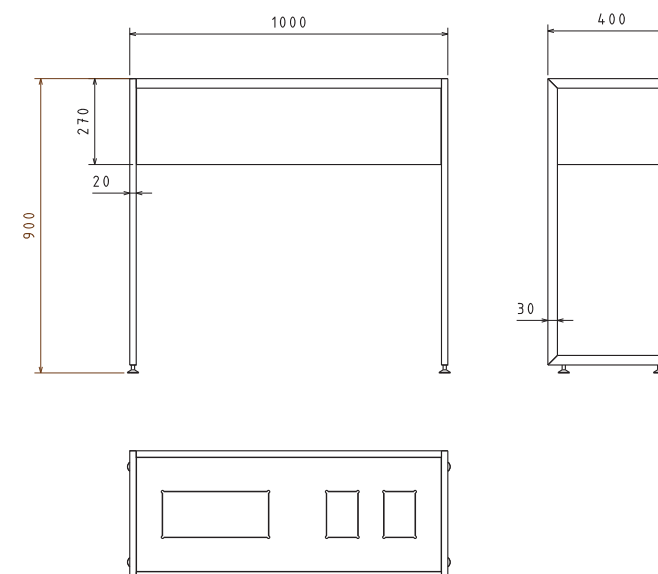

LATO 1:
piano predisposto per posizionamento rubinetti su basetta.

Possibilità di esporre:

2 lavabo monocomando su basetta singola
+
1 lavabo tre fori su basetta
oppure
2 lavabo (ideale)
oppure
3 lavabo monocomando su basetta singola

SIDE 1:
surface designed for positioning taps on a display base.

Possibility of displaying:

2 single-lever basin mixers on a single display base
+
1 three-hole basin mixer on a display base
or
2 mixers (ideal solution) on a display base
or
3 single-lever mixers on a single display base



LATO 2:
piano con superficie liscia predisposto per esporre rubinetti fissi, senza basetta

SIDE 2:
smooth countertop designed for positioning fixed taps, without the display base.



Espositori da sala mostra - Showroom displays

B EXPO VERTICALE - VERTICAL DISPLAY

code ESP027

Pannello espositivo con fissaggio a parete per esposizione di prodotti incasso doccia e soffioni a parete con o senza retroilluminazione.

Wall-mounted display panel for displaying built-in shower mixers and wall-mounted shower heads with or without backlighting.

code ESP030

(*) Possibilità di installare una/due mensole con lavabo su basetta.
Possibility of installing one/two shelves with taps on a display base.

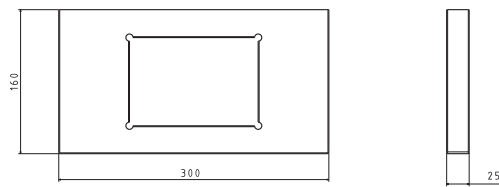

INDOOR

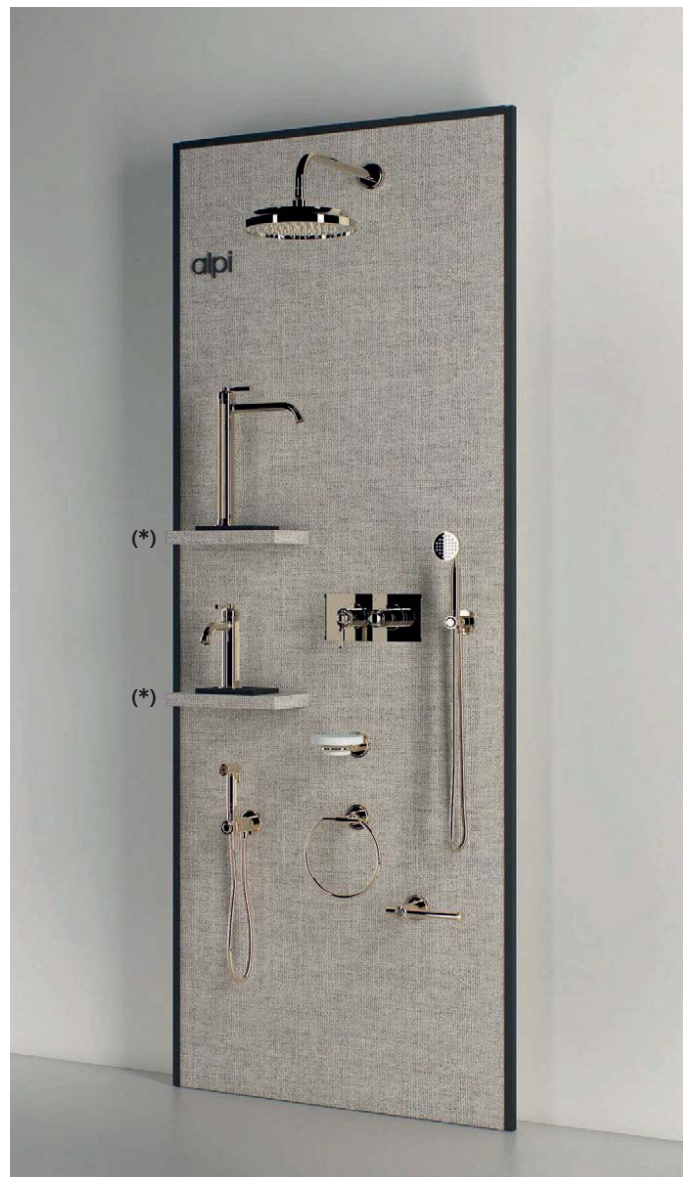

Con aggiunta LED per retroilluminazione.
With added LED backlighting.

code ESP031

code ESP027 + code ESP031

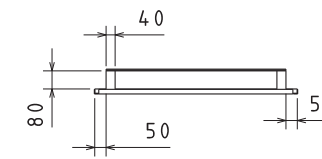
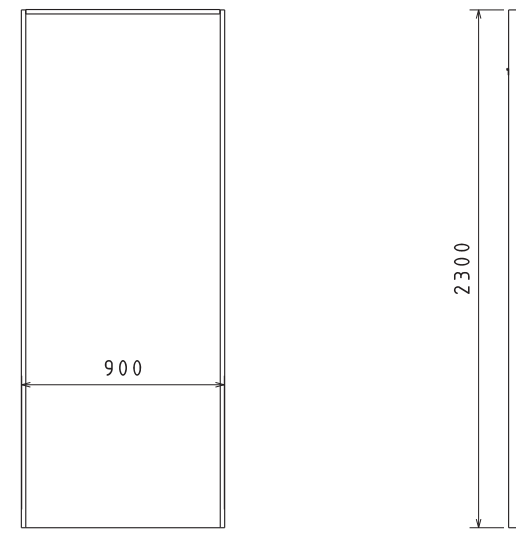
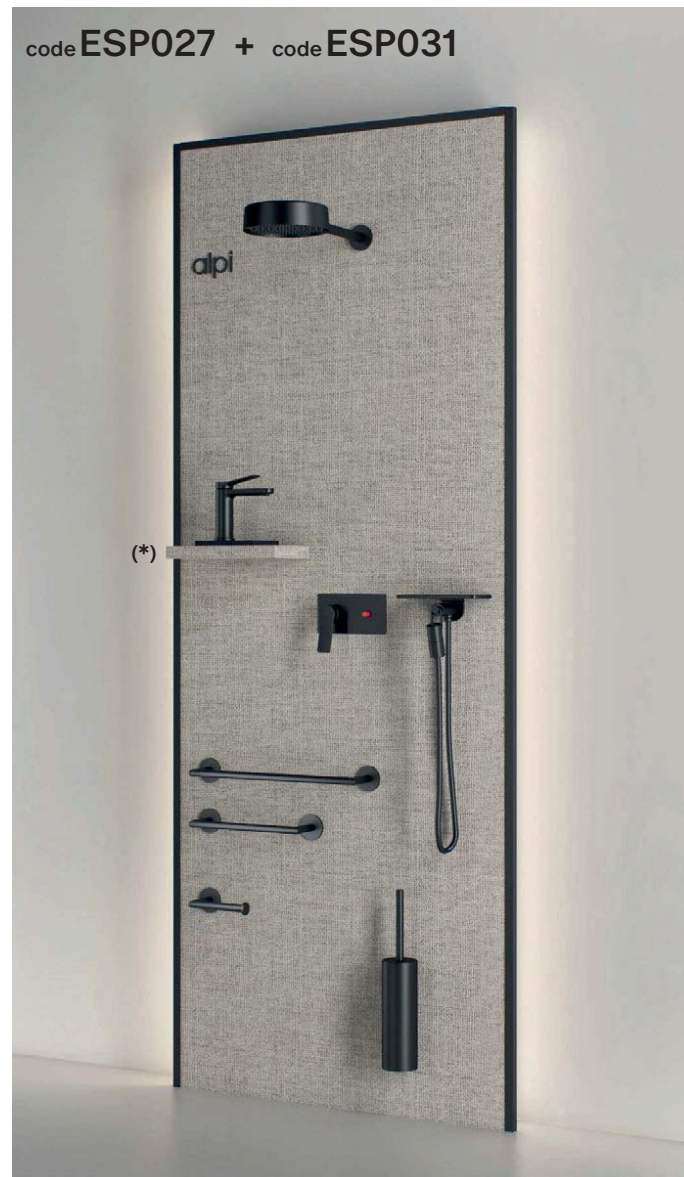

OUTDOOR



Con aggiunta LED per retroilluminazione.
With added LED backlighting.

code ESP031

code ESP027 + code ESP031

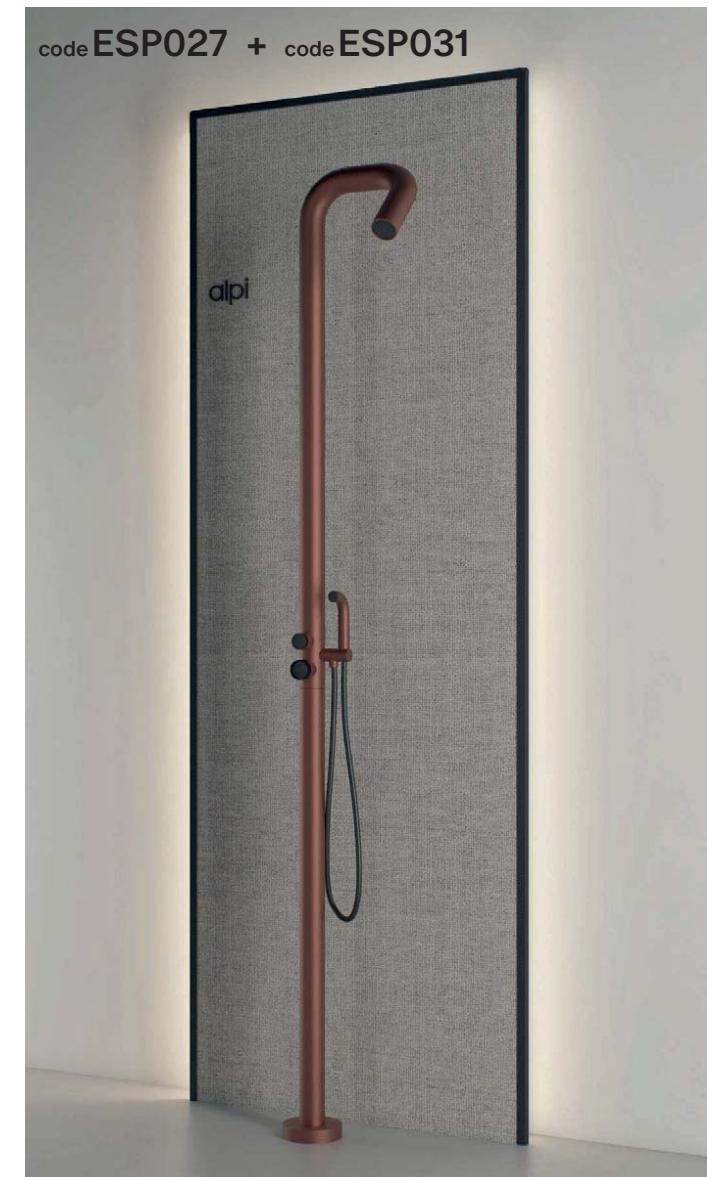

Espositori da sala mostra - Showroom displays

C EXPO VERTICALE CON CELINO- VERTICAL DISPLAY WITH CEILING

Pannello espositivo con celino con fissaggio a parete per esposizione di prodotti incasso doccia e soffioni a soffitto con o senza retroilluminazione.

Wall-mounted display panel with ceiling for displaying built-in shower heads and concealed shower mixers with or without backlighting.

code **ESP030**

Possibilità di installare una/due mensole con lavabo su basetta.
Possibility of installing one/two shelves with taps on a display base.

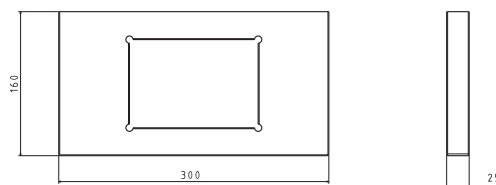

INDOOR CEILING



Con aggiunta LED per retroilluminazione.
With added LED backlighting. code **ESP031**



FADE
code **ESP028**

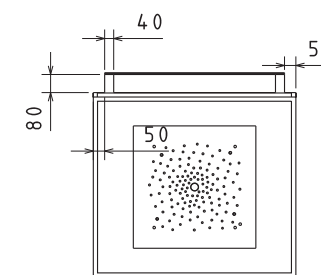

GROOVE (*)
code **ESP029**

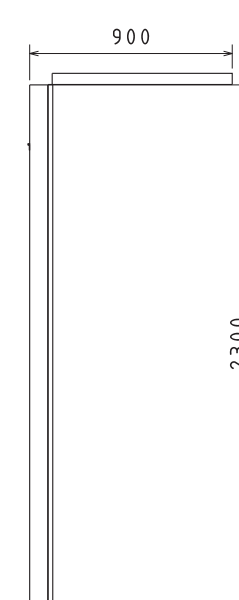
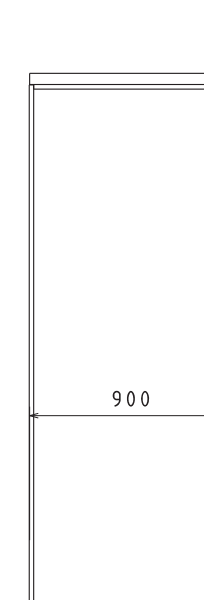
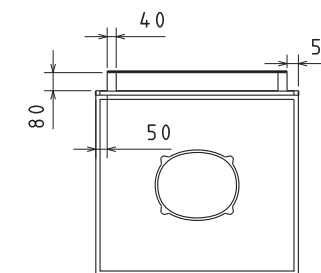

FADE

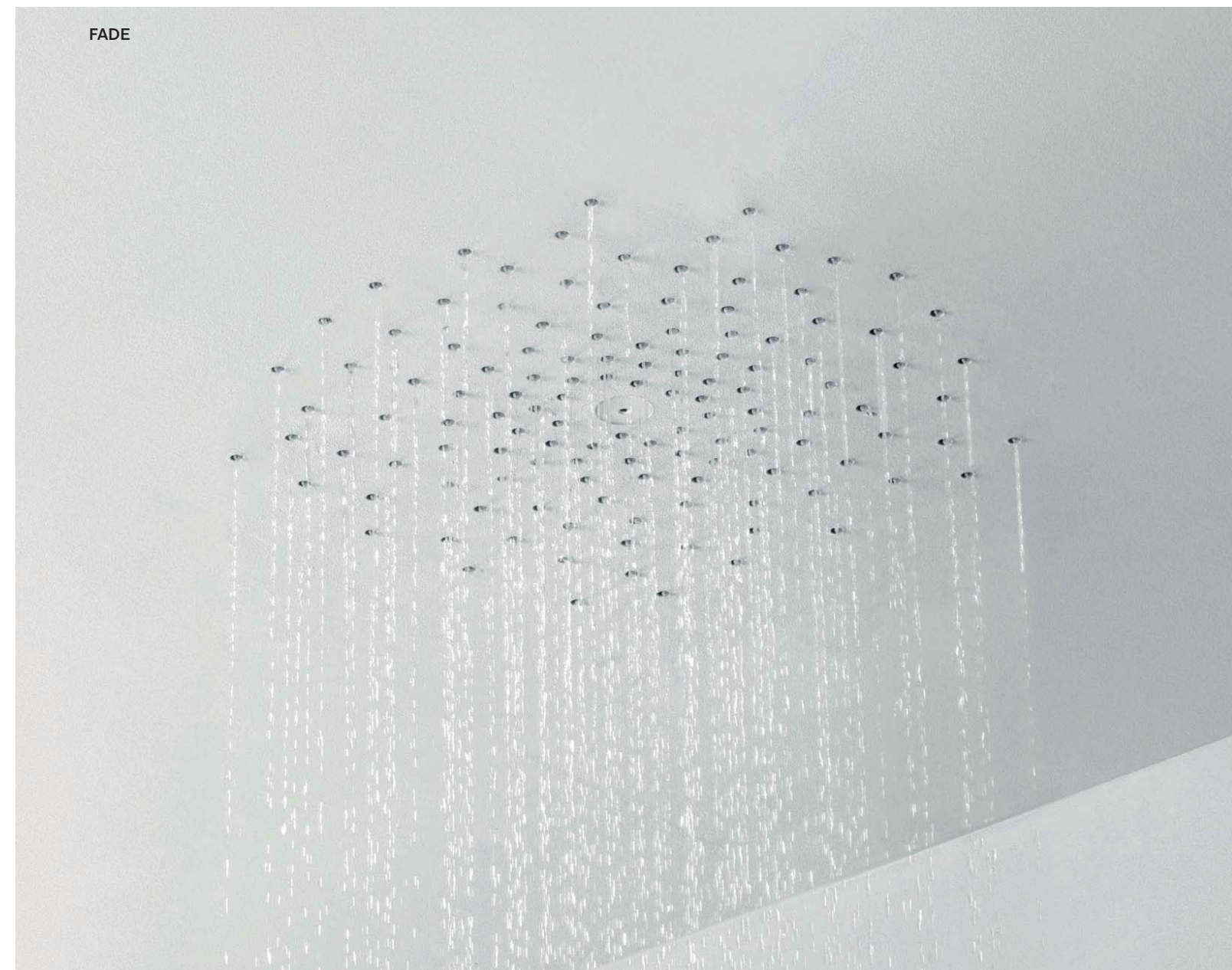

Esempi di configurazione - Examples

- ❶ FDP 04 PRSMBO
- ❷ PO ELV163D PRSMBO
- ❸ PO 050 PRSMBO
- ❹ PO 030 PRSMBO
- ❺ PO 045 PRSMBO
- ❻ PO 072 PRSMBO

- ❶ BD 050 POI
- ❷ SF 190 POI
- ❸ LG 14177 POI
- ❹ LG 14176 POI
- ❺ LG ELV863 POI
- ❻ KI 104 POI
- ❼ LG 080 POI
- ❽ LG 010 POI
- ❾ LG 020 POI
- ❿ LG 14111 POI

- ❶ GR O301 or GR 0201 or GR0303
- ❷ NU 24ELP263 NK
- ❸ KI 091 NK
- ❹ NU 24177/S NK
- ❺ NU 241476/S NK
- ❻ PRE 075 NK
- ❼ AC 357 NK

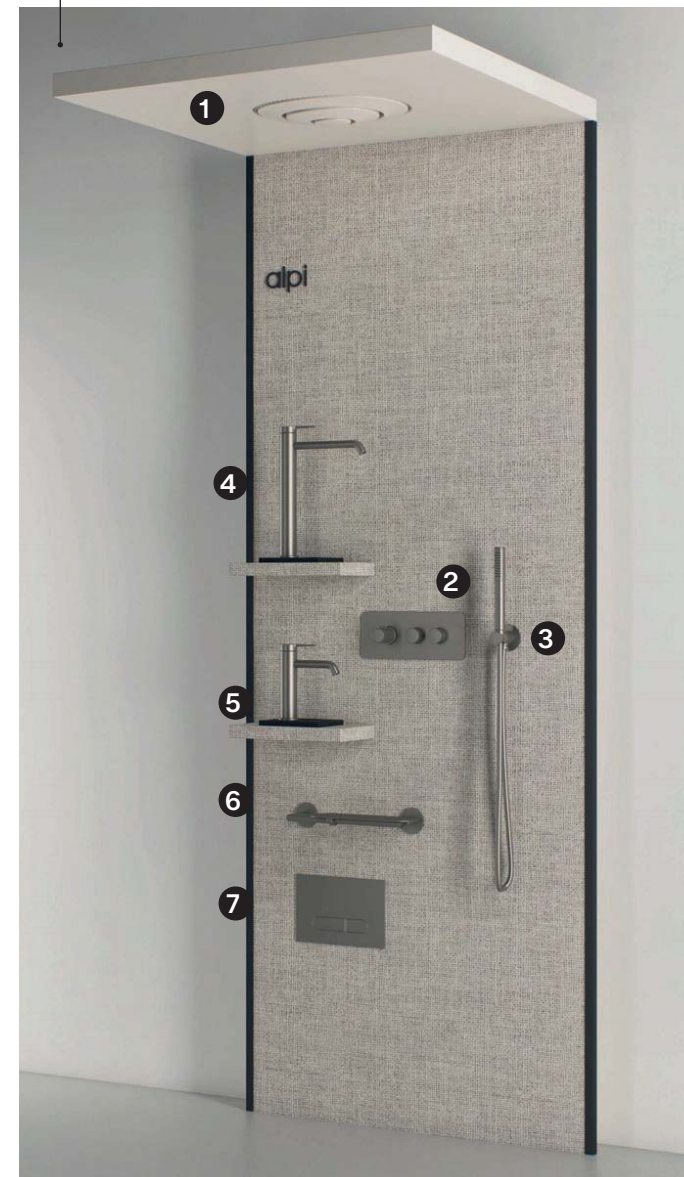
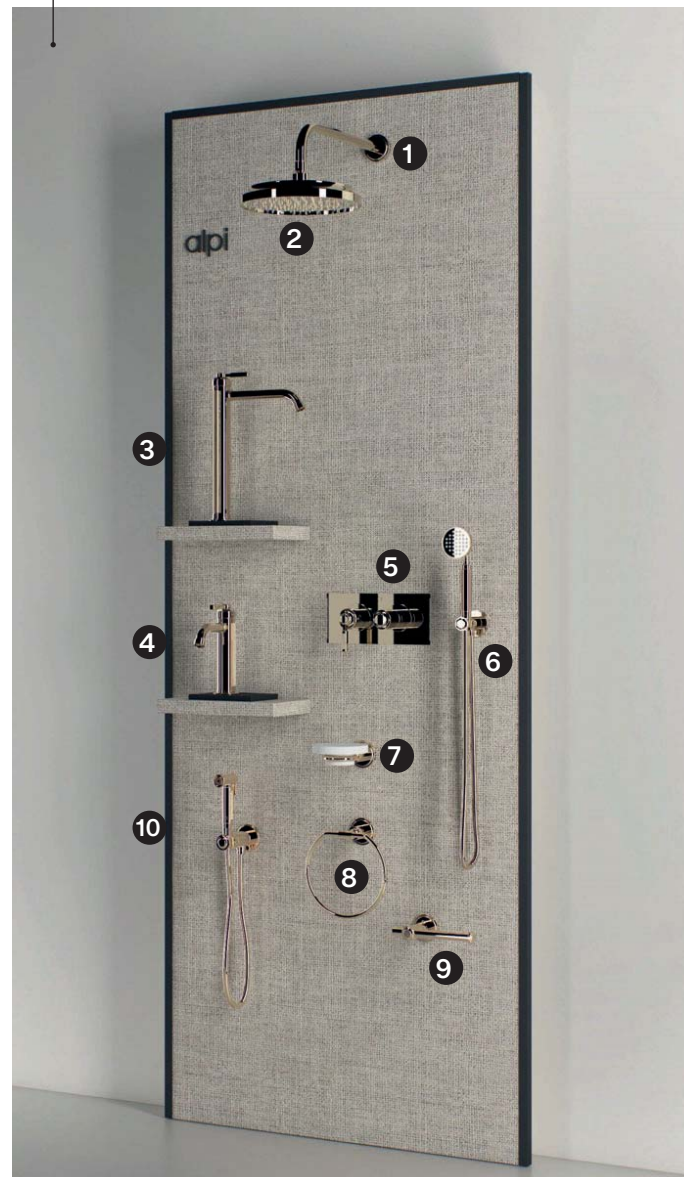

Prodotti su bassetta espositiva - Products on display base

D 1 FORO - 1 HOLE

code ESP-BAS 116



E 3 FORI - 3 HOLES

code ESP-BAS 118



Box Campionari - Samples Box



F VERO



G PORTOFINO



H LE GRAND



Groove

L GROOVE

code ESP-MINIGRO301

Modello in miniatura esplicativo del funzionamento del soffione Groove

Mini model explaining how the Groove showerhead works

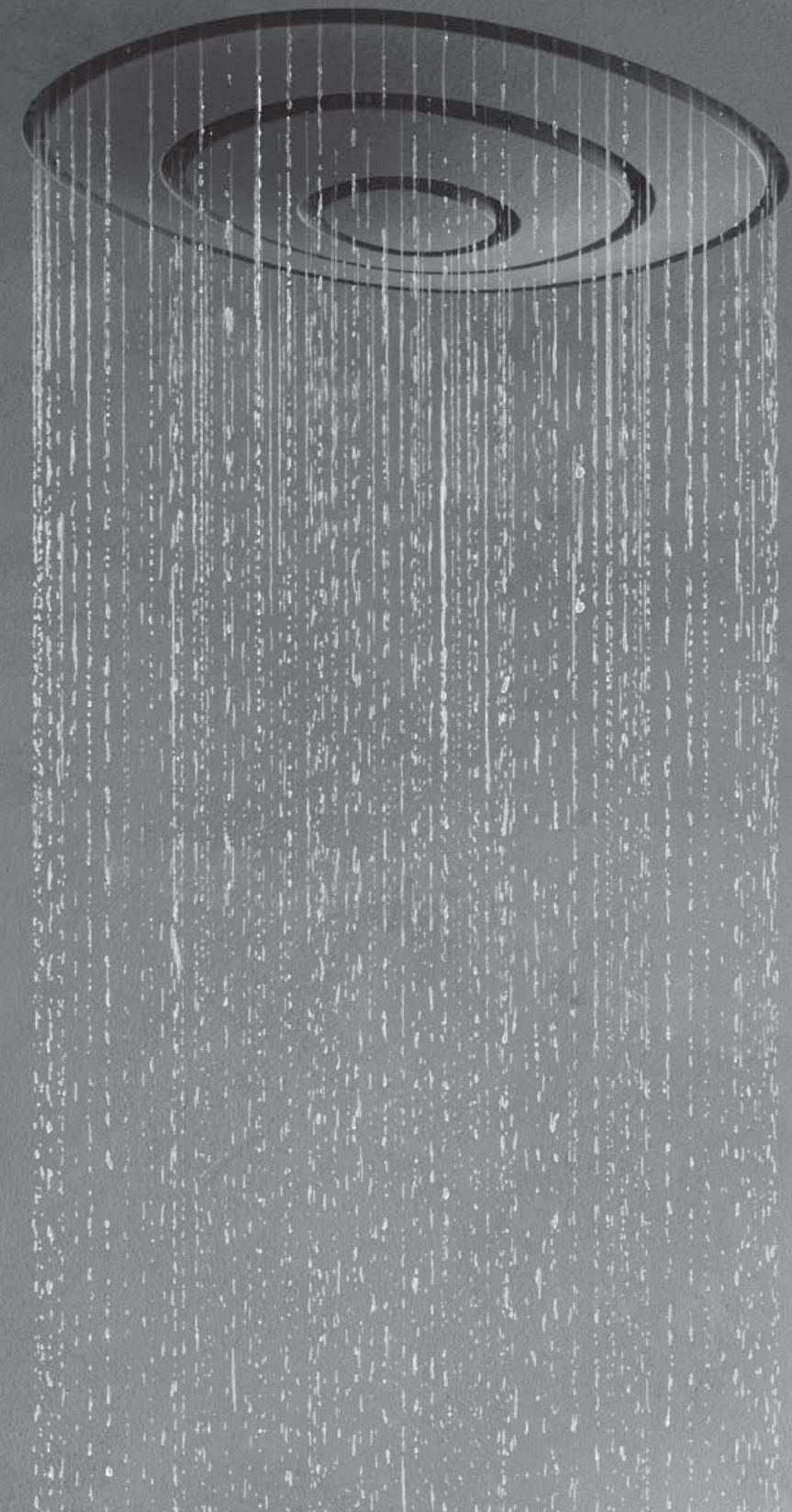
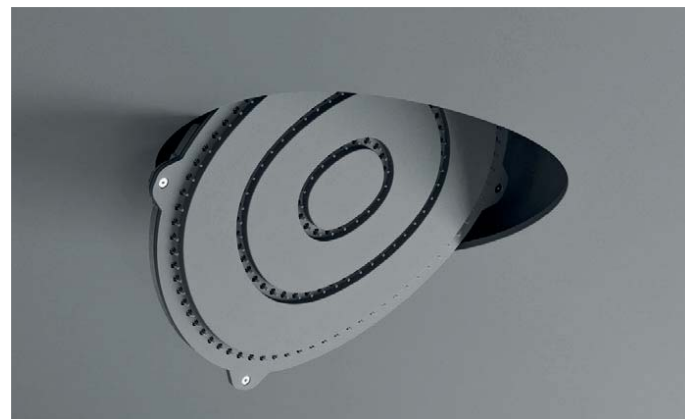

Finiture - Finishes

M INDOOR

code ESP.FINITURE.0124



N OUTDOOR

code ESP.FINOUTD.0123



Logo

O

code AC 306

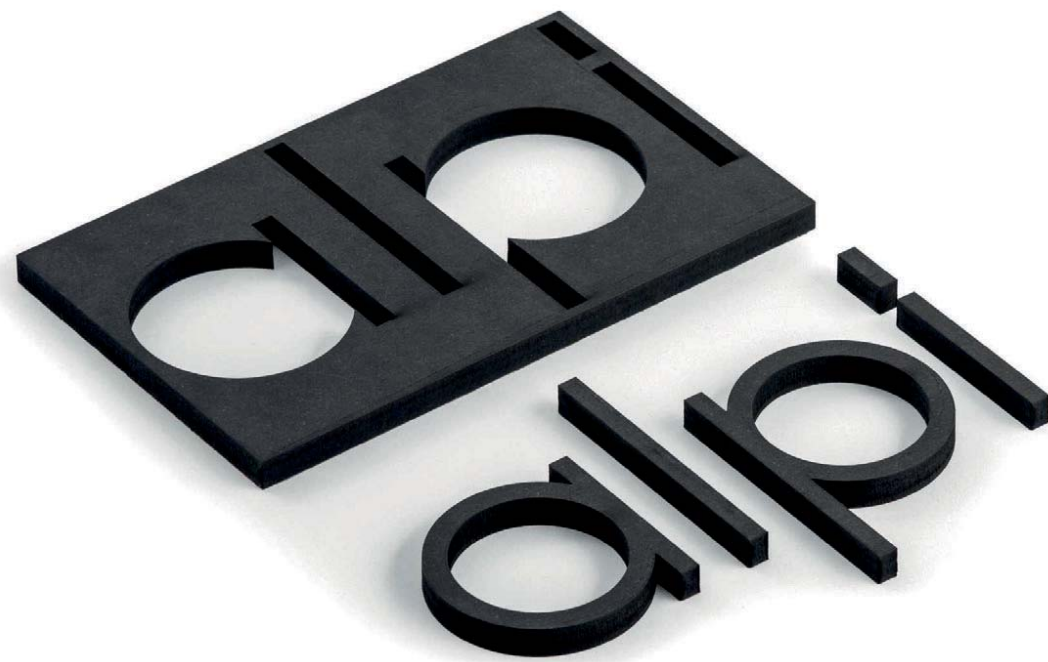
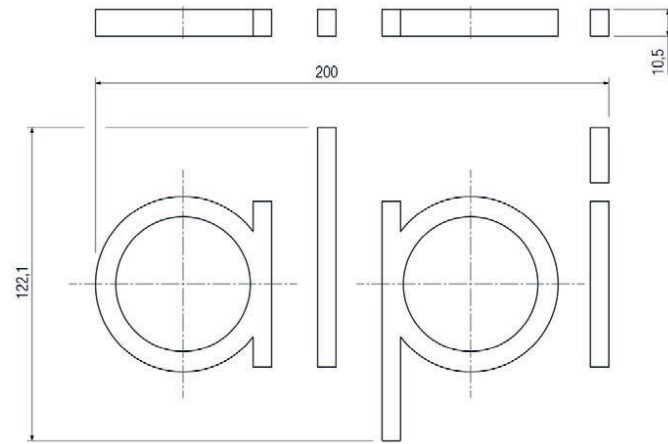

Alpi S.p.A.

Via Geola, 9
28013 Gattico Veruno (NO), Italia
+39 0322 838450
infoalpi@alpirubinerie.com
alpirubinerie.com



DERPROJED.0126 REV.01

“Alpi si riserva il diritto di apportare i cambiamenti che ritiene opportuni ad articoli e finiture al fine di migliorare il prodotto. Le illustrazioni e le descrizioni contenute nei nostri stampati non comportano obbligo di fedele riproduzione.

Alpi reserves the right to introduce the proper changes to the items and finishing in order to improve the product. Pictures and descriptions contained in our printed matter do not imply any obligation of faithful reproduction.”

